



30 LITRE DIGITAL AIR FRYER TOASTER OVEN

Cook different amazing food
with one device



543302 (AFO-09D-R)

When using electric appliances basic safety precautions should always be followed. Do not use BridgePro Air Fryer Toaster Oven until you have read this manual thoroughly.



TABLE OF CONTENTS

Important safeguards	2
Getting to know your air fryer toaster oven	4
• Main component	4
• Features	5
• Technical specifications	5
• LED control panel	6
Before using your air fryer toaster oven	9
Operation guide	10
Cooking functions quick reference chart	14
Dual cook functions quick reference chart	15
Replacing the light	16
Disassembling the inner glass door for cleaning	17
Care, Cleaning & Storage	18
Troubleshooting	20

IMPORTANT SAFEGUARDS

Always follow basic safety precautions when using your Air Fryer Toaster Oven.

READ ALL INSTRUCTIONS BEFORE USE

- Unplug from outlet when not in use and before cleaning. Allow to cool before cleaning or handling, putting on or taking off parts.
- **Do not** touch hot surfaces without using heat-protective gloves. To avoid burns, use extreme caution when removing hot accessories or disposing of hot grease.
- **Do not** immerse cord, plug or any parts of Air Fryer Toaster Oven in water or other liquid to prevent against electrical hazard.
- To avoid potential hazards, please do not put the product next to or used by children.
- **Do not** operate any appliance with a damaged cord or plug. If the appliance is dropped or damaged, please return product to original store or retailer for proper inspection and repair.
- To avoid potential injury, do not use accessories or attachments not recommended for the unit.
- **Do not** use outdoors.
- **Do not** let the cord hang over the edge of a surface where the potential of child or pet interaction is present.
- **Do not** place on or near a hot gas or electric burner.
- **Do not** use this appliance for other than intended use.
- Extreme caution should be exercised when using containers constructed of materials other than metal or glass in the Air Fryer Toaster Oven.
- **Do not** store any materials other than manufacturer's recommended accessories in this appliance when not in use.
- **Do not** place any of the following materials in this appliance: cardboard, plastic, paper, or anything similar.
- Oversized foods and utensils must not be inserted in an Air Fryer Toaster Oven as they may involve a risk of fire or electric shock.

Do not use this air fryer oven for any purpose other than that described in this manual.

IMPORTANT SAFEGUARDS

- A fire may occur if the appliance is covered or near to flammable materials such as curtains, tableclothes or walls when in operation.
- Do not store any items on top of the appliance when in operation.
- **Do not** clean with metal scouring pads. Pieces can break off the pad and touch electrical parts, causing a risk of electric shock.
- **Warning:** To avoid possibility of fire, **Never** leave the appliance unattended during use. Use recommended temperature settings for all function.
- **Do not** rest cooking utensils or baking dishes on glass door.
- **Do not** operate your appliance in an appliance garage or under a wall cabinet. When storing in an appliance garage, always unplug the unit from the electrical outlet.
- Check if the voltage indicated on the appliance corresponds to the local main voltage before connecting the appliance.

FOR HOUSEHOLD USE ONLY
SAVE THESE INSTRUCTIONS

GETTING TO KNOW YOUR AIR FRYER TOASTER OVEN

MAIN COMPONENTS

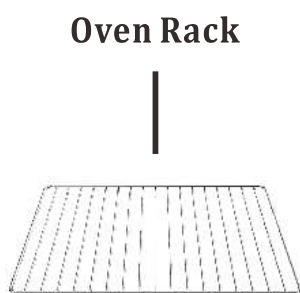

Oven Rack : Used for meat, bread, pizza etc.

Air Fryer Basket : Use the Air Fryer Basket in conjunction with the Air Fry function to optimize your cooking results. Used for fries, chicken wings, onion etc. It also could be used as the dehydrate basket.

Baking Pan : Used for cookies, cake, turkey etc. It can also hold the drippings from the food or oil when Airfrying.

Rotisserie : Used for chicken, turkey, meat.

Remove Handle : Used to remove the rotisserie from the oven.

Crumb tray: Used for the crumbs of food.

Please clean with soap and water.

FEATURES

By using all-new 360° HOT AIR CIRCULATION technology, The Air Fryer Toaster Oven can offer you more delicious and healthier cuisine.

DOOR SENSOR

If the door is opened during cooking, the cooking will pause and the

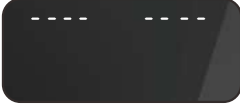
light will turn on. The panel will show . When the door is closed, the light will turn off and resume cooking. Please make sure to keep the oven door closed during cooking.

TECHNICAL SPECIFICATIONS

Voltage	Power	Frequency	Capacity
220V-240V	1800W	50Hz	30L

LED Control Panel

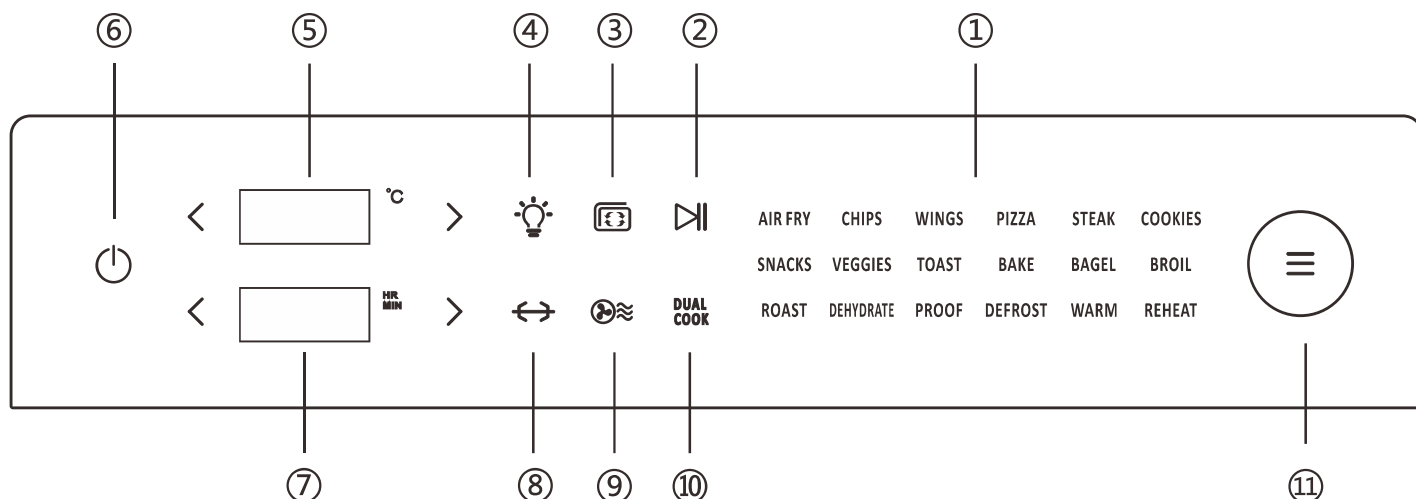

① AirFryer Toaster Oven Functions Overview

PRESET	DEFAULT TEMPERATURE	DEFAULT TIME	TEMP RANGE	TIME RANGE
AIR FRY (Fried Food)	200°C	10MINS	90-230°C	Up to 2 HOURS
CHIPS (Frozen French Fries)	230°C	18MINS	90-230°C	Up to 2 HOURS
WINGS	230°C	18MINS	90-230°C	Up to 2 HOURS
PIZZA	230°C	11MINS	90-230°C	Up to 2 HOURS
STEAK	230°C	7MINS	90-230°C	Up to 2 HOURS
COOKIES	180°C	15MINS	90-230°C	Up to 2 HOURS
SNACKS	200°C	18MINS	90-230°C	Up to 2 HOURS
VEGGIES	230°C	15MINS	90-230°C	Up to 2 HOURS
TOAST			1~7	1~7MINS
BAKE	175°C	25MINS	90-230°C	Up to 2 HOURS
BAGEL	230°C	13MINS	90-230°C	Up to 2 HOURS
BROIL	230°C	10MINS	90-230°C	Up to 2 HOURS

Rotate the knob in clockwise or anti-clockwise direction to select above presets and press to confirm.

LED Control Panel

PRESET	DEFAULT TEMPERATURE	DEFAULT TIME	TEMP RANGE	TIME RANGE
ROAST	200°C	30MINS	90-230°C	Up to 2 HOURS
DEHYDRATE	60°C	5HOURS	30-80°C	1-12 HOURS
PROOF	34°C	45MINS	30-40°C	Up to 8 HOURS
DEFROST	50°C	20MINS	30-80°C	Up to 2 HOURS
REHEAT	95°C	5MINS	90-230°C	Up to 2 HOURS
WARM	50°C	4HOURS	30-120°C	Up to 8 HOURS

The above default data are for reference only, the user can adjust the desired temperature and time as required.

② START/PAUSE

Touch "START/PAUSE" icon to start or stop the program.

③ PREHEAT

After selecting a program and adjusting the temperature, touch "PREHEAT" icon to preheat the Air Fryer Toaster Oven. (No need to touch the "START/PAUSE" icon to start the preheat program. After preheating, the oven will beep 5 times and "Add food" will be showed on the display.)

④ LIGHT SWITCH

Touch "LIGHT" icon to turn the oven light On/Off. (Without any operation after 5 minutes, the light will turn off automatically. It will turn on again when you touch.)

⑤ TEMPERATURE MODIFICATION

Touch " < " icon to decrease the temperature as needed, Touch " > " icon to increase the temperature as needed, long press the icon for rapid setting.

LED Control Panel

⑥ POWER ON/OFF

Touch “POWER ON/OFF” icon to turn the Air Fryer Toaster Oven On/Off.

⑦ < ^{HR}_{MIN} > TIME MODIFICATION

Touch “ < ” icon to decrease the time as needed, Touch “ > ” icon to increase the time as needed, long press the icon for rapid setting.

⑧ ROTISSERIE

It is used to cook all the food that need to be rotated. After selecting the desired program and setting the temperature/time, touch the start icon to start cooking and then touch the rotisserie icon.

⑨ AIR FRY

This icon is for display only. If the program with fan running is adopted, the icon will keep flashing during operation

⑩ **DUAL COOK** **DUAL COOK**

Advanced dual function cooking technology allows you to program your Air Fryer Oven to start cooking with one preset, then automatically transition to a second preset for a perfect cook on any meal. For example, put a breadcrumb-topped casserole in the oven, set it to bake then broil, and it will cook through with a golden crisp topping to finish. Just set it and forget it. Enjoy your favorite fried food without any extra operation.

⑪ MENU

You can select the menus by rotating the menu knob, to choose the next menu by rotating it clockwise, to choose the last menu by rotating it counterclockwise, after select the menu, press the menu button to begin the cooking.

BEFORE USING YOUR AIR FRYER TOASTER OVEN

- 1** Remove all packaging around and inside the oven.

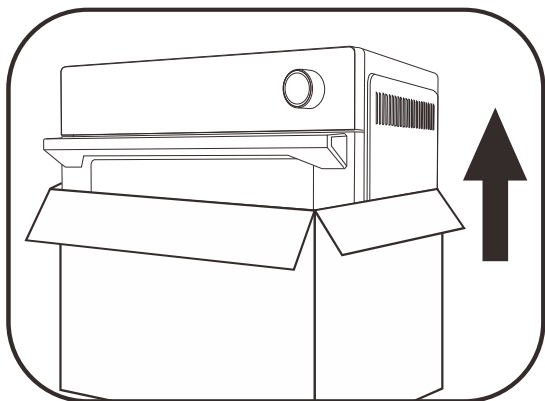

- 2** Place on a stable, level, heat-resistant surface, away from anything that can be damaged by heat. Keep at least 110 mm distance between the electrical outlet and the wall, furniture, etc.

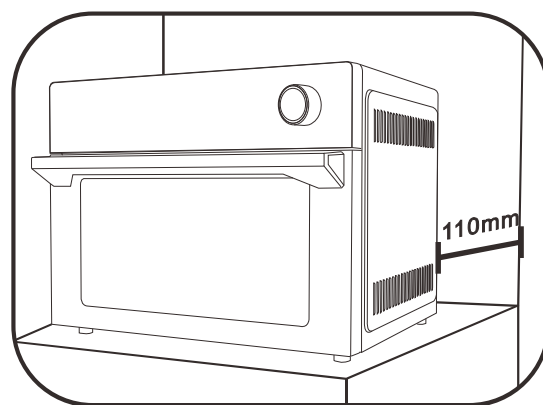

- 3** Remove the protective film from the control panel. (This film is to protect the panel, you can tear it off or keep it.)

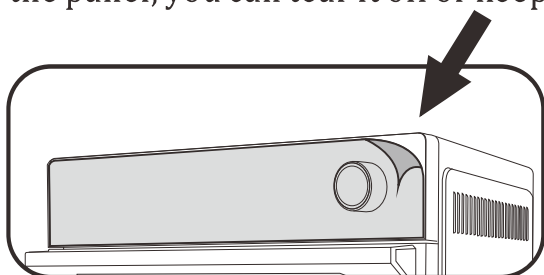

- 4** Wash all accessories and clean the interior of the Air Fryer Toaster Oven. Dry and place accessories back in oven.

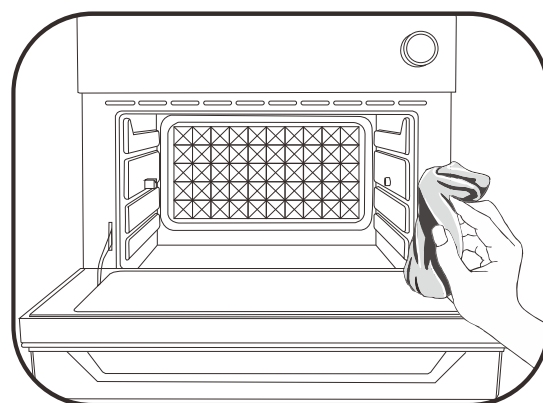

- 5** Before use, ensure that the power and outlet meet the requirements to operate this product (input power requirements).

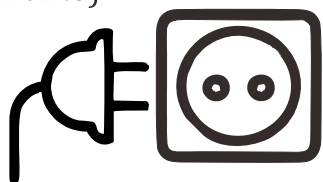



- 6** Upon first use, it is necessary to run the oven for 18 minutes at the highest temperature (230°C) in order to sterilize and remove any manufacturing odor. The Air fryer Toaster Oven may emit an odor or smoke due to the heater's protective film.



OPERATION GUIDE







1 

Plug in, touch the POWER ON/OFF icon to turn on the Air Fryer Toaster Oven, screen will illuminate and "AIR FRY" icon will blink.

2 



Rotate the menu knob to choose the menus you want, and the default temperature and time will show on the display, users can adjust the temperature and time as desired with touching  and , and press the menu button to begin the cooking.

Note: The temperature on the "Toast" function cannot be adjusted. Touch the time duration  for level 1~level 7 of the toast.

3 
 PREHEAT



Touch the "PREHEAT" icon in order to preheat the Air Fryer Toaster Oven. When the internal temperature reaches 150C, the "Add Food" signal will appear. (After preheating, put the food in oven and close the door, the program will start cooking automatically.)

Note: The Toast, Dehydrate, Proof, Defrost, Reheat and Warm programs do not require preheating

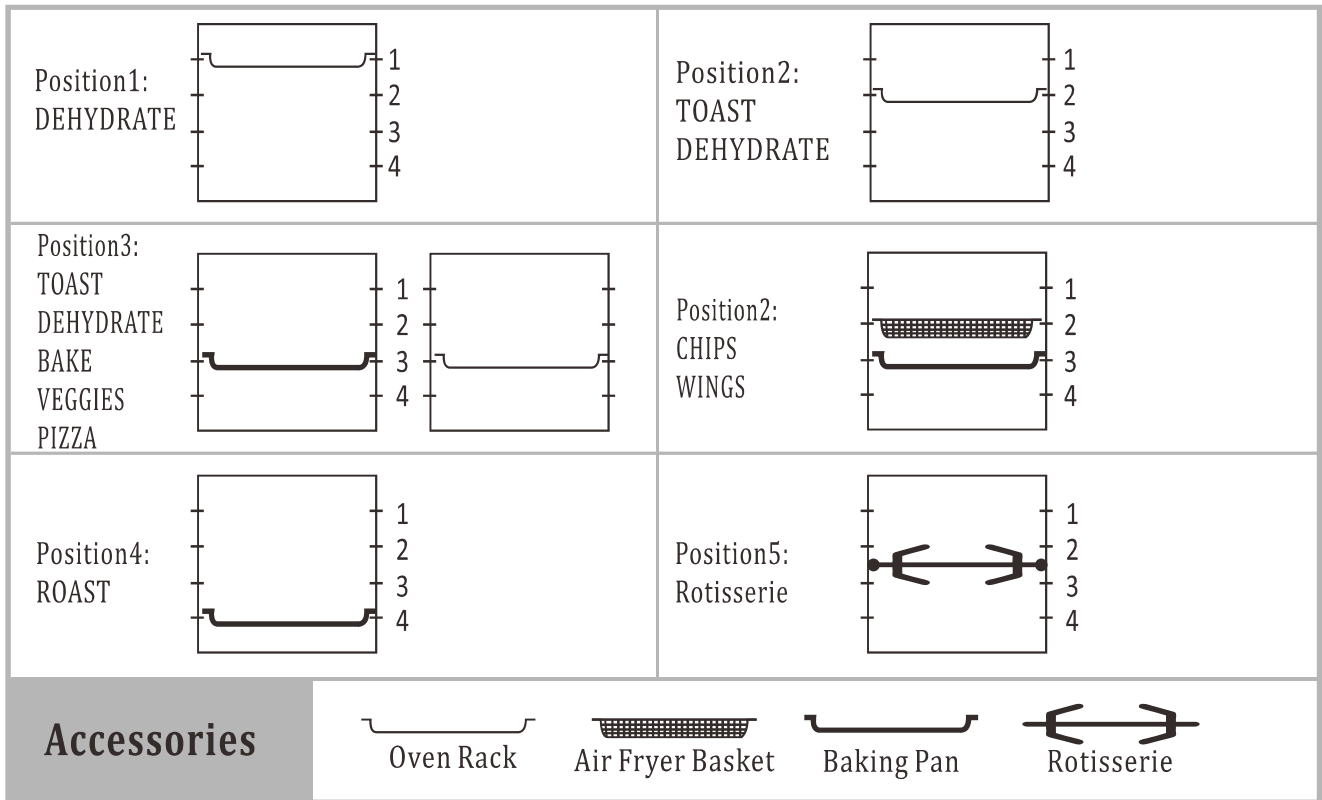
OPERATION GUIDE



Note: When cooking fatty foods (e.g. chicken wings) with the oven rack, air fryer basket or rotisserie, place the baking pan in the slot underneath in order to prevent oil from dripping on to the stainless-steel heater.

4 Accessories position

Insert the accessories with food into the desired position then close the door. There are four groove positions, that can be seen in the above rack position diagrams to place the accessories.

Note: If you need to use the rotisserie, fix the food and place it in the air fryer oven.

5 START/PAUSE

If you skip the preheat function of step 3, please touch the START/PAUSE icon to begin cooking, and the display will show the timer counting down. When cooking is done, the oven will beep 5 times, the display will show "END", and all menu icons will light up.

Note: To use the rotisserie, touch the rotisserie icon after touching START/PAUSE icon.

End

Note: The display will continue to show "END" until the menu icon is pressed. After cooking is complete, the fan will continue to run for 4 minutes in order to properly cool the appliance.

DUAL COOK



1

Plug in, touch the POWER ON/OFF to turn on the Air Fryer Toaster Oven, screen will illuminate and “AIR FRY” icon will blink.

Eg:

First step





Second step



2 Dual Cook

Touch the DUAL COOK icon, five programs AIR FRY/BAKE/BROIL/ROAST/WARM will illuminate, rotate the menu knob “” to select the first program you needed, e.g. “AIR

FRY”, and the selected “AIR FRY” will flash (the other four lights will stay illuminated), then touch the  icon to adjust the desired temperature, touch the  icon to adjust the desired time, finally touch the menu icon to confirm the first program AIR FRY; The remaining four icons will stay illuminated, repeat the above operation to adjust the second program.

Note: If you want to cancel the DUALCOOK function, you can touch the START/PAUSE icon, and then touch the DUALCOOK icon to return to the general menu.

DUAL COOK

POWER ON

Dual Cook

Preheat

Accessories
position

START

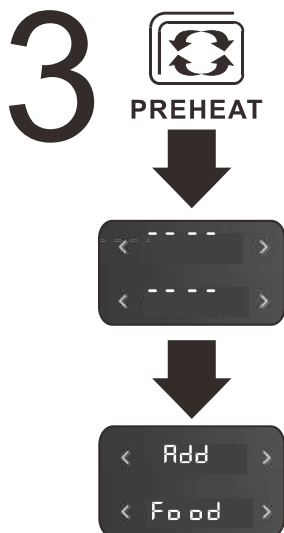

Touch the "PREHEAT" icon in order to preheat the Air Fryer Toaster Oven. When the internal temperature reaches 150C, the "Add Food" signal will appear. (After preheating, put the food in oven and close the door, the program will start cooking automatically.)



Insert the accessories with food into the desired position then close the door. There are four groove positions, please see the above rack position diagrams to place the accessories.



If you skip the preheat function of step 3, please touch the START/PAUSE icon to begin cooking, and the display will show the timer counting down, the selected first program will be displayed, and the selected second program will not be displayed until the first program is completed. When cooking is done, the oven will beep 5 times, the display will show "END", and all menu icons will light up.

Note: To use the rotisserie, touch the rotisserie icon after touching START/PAUSE icon.



End

Note: The display will continue to show "END" until the menu icon is pressed. After cooking the fan will continue to run for 4 minutes in order to properly cool the appliance.

COOKING FUNCTIONS

QUICK REFERENCE CHART

FUNCTION	PRE-HEAT	Suggested Amount of Food	Suggested Accessory	Suggested Rack Position
AIR FRY	Yes	base on the food you select	Air Fryer Basket	2
CHIPS	Yes	550g	Air Fryer Basket	2
WINGS	Yes	1038g(28pcs)	Air Fryer Basket	2
PIZZA	Yes	13 inches	Baking Pan or Oven Rack	3
STEAK	Yes	190 g	Baking Pan or Oven Rack	2
COOKIES	Yes	base on the food you select	Baking Pan	2
SNACKS	Yes		Baking Pan or Oven Rack	3
VEGGIES	Yes		Baking Pan or Air Fryer Basket	3
TOAST	No	6pcs	Oven Rack	2or3
BAKE	Yes	base on the food you select	Baking Pan or Oven Rack	3
BAGEL	Yes		Baking Pan or Air Fryer Basket	2
BROIL	Yes		Baking Pan or Oven Rack	2
ROAST	Yes		Baking Pan or Rotisserie	4 or Rotisserie position

COOKING FUNCTIONS QUICK REFERENCE CHART

FUNCTION	PRE-HEAT	Suggested Amount of Food	Suggested Accessory	Suggested Rack Position
DEHYDRATE	No	base on the food you select	Air Fryer Basket	1 or 2 or 3
PROOF	No		Baking Pan	3
DEFROST	No		Baking Pan	2
REHEAT	No		Oven Rack	3
WARM	No		Baking Pan	2

DUAL COOK FUNCTIONS QUICK REFERENCE CHART

FUNCTION 1	FUNCTION 2	PREHEAT	Suggested Amount of Food	Suggested Accessory	Suggested Rack Position
AIR FRY	WARM	Yes	Base on the food you select	Air Fryer Basket	2
BAKE	BROIL	Yes	Base on the food you select	Baking Pan or Oven Rack	3
AIR FRY	WARM	Yes	Base on the food you select	Baking Pan or Rotisserie Fork	4 or Rotisserie fork position
ROAST	AIR FRY	Yes	Base on the food you select	Baking Pan or Rotisserie Fork	4 or Rotisserie fork position
AIR FRY	BROIL	Yes	Base on the food you select	Air Fryer Basket or Oven Rack	2 or 3

It is a normal occurrence that some moisture may occur on the oven door during the cooking process. We would like to recommend that you preheat the Air Fryer Toaster Oven before cooking.

REPLACING THE LIGHT

ATTENTION: Be sure to unplug the Air Fryer Toaster Oven and allow it to cool completely before replacing the oven light.

SPECIFICATION: 25W halogen bulb

1. Rotate the light cover clockwise to remove it.

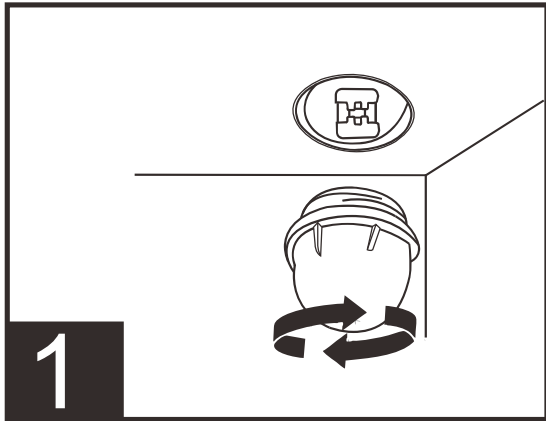

2. Remove the used bulb by pulling it directly.

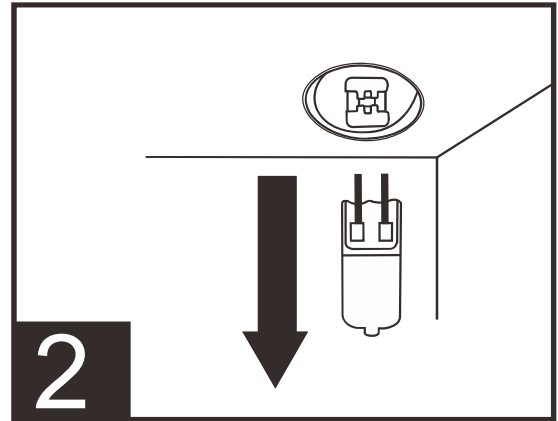

3. Insert the new bulb

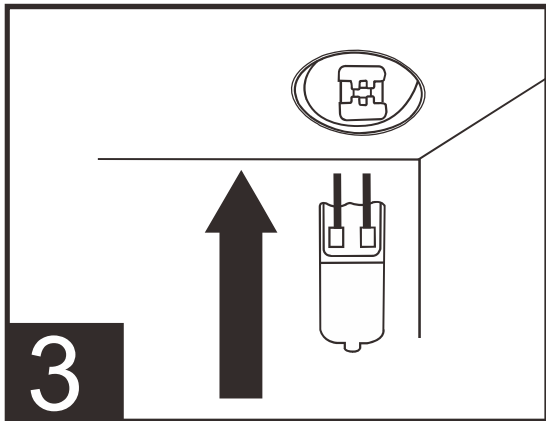

4. Rotate the light cover counterclockwise to tighten it.



DISASSEMBLING THE INNER GLASS DOOR FOR CLEANING

Attention: Be sure to cool down the glass door completely before disassembly.

1. Users can turn on the screw counterclockwise with a screwdriver
2. User can use the silicone suction cup to lift up the glass, and then take out the glass with hands.
3. After cleaning and drying the glass, users put the glass back and turn the screw clockwise to replace it.

1

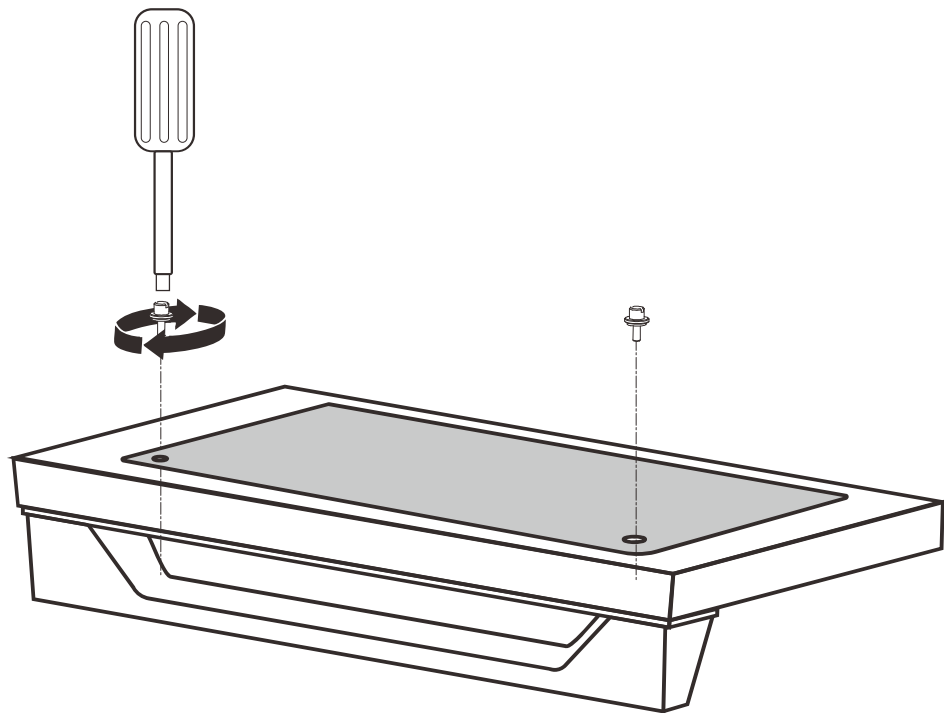

2

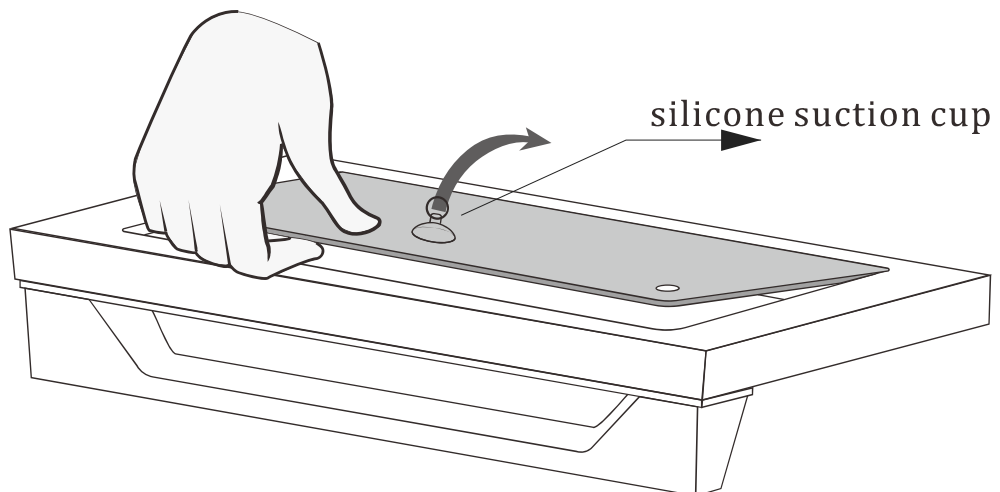

CARE, CLEANING & STORAGE

Before cleaning, remove the power plug from the power outlet. Allow the oven and all accessories to cool completely before disassembling and cleaning.

Cleaning the outer body and door

- Wipe the outer body with a soft, damp sponge. A non-abrasive liquid cleanser or mild spray solution may be used to avoid build-up of stains. Apply the cleanser to the sponge, not the oven's surface, before cleaning.
- To clean the glass door, use a glass cleaner or mild detergent and a soft, damp sponge or soft plastic scouring pad. Do not use an abrasive cleanser or metal scouring pad as these will scratch the oven's surface.
- Wipe the LED screen with a soft, damp cloth. Apply cleanser to the cloth, do not apply cleanser directly on to the LED. Cleaning the LED screen surface with a dry cloth and/or abrasive cleaners may produce scratches.



WARNING: To prevent electrocution, do not immerse the appliance or power cord into water or any other liquid.

Cleaning the interior

- To clean any spattering that may occur while cooking, wipe the walls with a soft, damp sponge. A non-abrasive liquid cleanser or mild spray solution may be used to avoid build-up of stains. Apply the cleanser to the sponge, not the interior, before cleaning.



WARNING: Use extreme caution when cleaning the heating elements. Allow the oven to cool completely, and then gently rub a soft, damp sponge or cloth along the length of the heating element. Do not use any type of cleanser or cleaning agent. Let all surfaces dry thoroughly prior to inserting the power plug into a power outlet and turning the oven on.

Cleaning the crumb tray

- After each use, slide out the crumb tray and discard crumbs. Wipe the tray with a soft, damp sponge. A non-abrasive liquid cleanser or mild spray solution may be used to avoid build-up of stains. Apply the cleanser to the sponge, not the tray, before cleaning. Dry thoroughly.
- To remove the baked-on grease, soak the tray in warm soapy water then wash with a soft sponge or soft plastic scouring pad. Rinse and dry thoroughly.
- Always ensure to re-insert the crumb tray into the oven after cleaning and prior to inserting the power plug into a power outlet and turning the oven on.

CARE, CLEANING & STORAGE

Cleaning the Oven rack, baking pan, fry basket, and remove handle.

- Wash all accessories in warm soapy water with a soft sponge or soft plastic scouring pad. Rinse and dry thoroughly. Do not use abrasive cleansers, metal scouring pads or metal utensils to clean any of the accessories as they may damage the surfaces.
- To extend the life of your accessories, cleaning them in the dishwasher is not recommended.

Storage

- Ensure the oven and all accessories are clean and dry.
- Ensure the door is closed.
- Store the appliance in an upright position, standing level and on its supporting legs. Do not store appliance when wet or hot. Do not store in a wet or hot environment.

Trouble shooting

Possible Problem	Possible Cause	Solution
The oven does NOT work	The appliance is not plugged in	Make sure the oven is plugged in.
	You have not turned on the oven	Touch the POWER ON/OFF icon to power on
	The door is not closed properly	Make sure the door is closed well.
Steam is coming out from the top of the oven door	You are cooking high moisture content foods	This is normal. The door is vented to release steam created from high-moisture content foods such as frozen breads.
White smoke is coming out of the oven	This is the first time using the oven	This is normal upon first use. We suggest setting the oven to the highest temperature and letting it run empty from 18-20 minutes.
	You're cooking greasy food	This is normal when cooking greasy foods. This will not affect the cooking process.
	The baking pan, crumb tray, or heaters still contain grease or oil residue from previous use	Ensure each component is properly cleaned after each use.
Dark smoke is coming out of the oven	Food is burning	Immediately turn off the oven, be careful when you take out the food.

Possible Problem	Possible Cause	Solution
The ingredients cooked with the oven are not done	Too much food in the oven at once	Reduce the amount of food in the oven when cooking.
	Setting temperature too low or time too short	Set the temperature higher or time longer.
	Choose the incorrect function	Make sure you cook with the proper function.
Foods are cooked unevenly	Ingredients are stacked or close to each other during cooking	Make sure food and ingredients are spread out evenly.
	Baking pan, Air Fry basket or oven rack position is not adjusted	Adjust oven inserts into the proper position. Take caution as these components may be hot.
Foods are not crispy after Air Frying	Ingredients with high moisture	Spraying or brushing a small amount of oil on food evenly can increase crispiness.
Display shows Error Code "E1"	There is a short circuit in the temperature monitor	Remove the power cord from the power outlet. Contact Customer Support.
Display shows Error Code "E2"	The temperature monitor or heaters is inoperative	Remove the power cord from the power outlet, reconnect and operate again. If it cannot be solved, then Contact Customer Support.