



30 LITRE DIGITAL AIR FRYER TOASTER OVEN

Cook different amazing food
with one device



543302-1

When using electric appliances basic safety precautions should always be followed. Do not use BridgePro Air Fryer Toaster Oven until you have read this manual thoroughly. Download our Recipe Cookbook at www.bgepro.com/bridgepro-air-fryer-recipes



TABLE OF CONTENTS

Important safeguards	2
Getting to know your air fryer toaster oven	4
• Main component	4
• Features	5
• Technical specifications	5
• LED control panel	6
Before using your air fryer toaster oven	9
Operation guide	10
Cooking functions quick reference chart	14
Dual cook functions quick reference chart	15
Replacing the light	16
Disassembling the inner glass door for cleaning	17
Care, Cleaning & Storage	18
Trouble shooting	19
Warranty	20
Warranty Terms and conditions	22
Warm Tip	23
Notes	25

IMPORTANT SAFEGUARDS

Always follow basic safety precautions when using your Air Fryer Toaster Oven.

READ ALL INSTRUCTIONS BEFORE USE

- Unplug from outlet when not in use and before cleaning. Allow to cool before cleaning or handling, putting on or taking off parts.
- **Do not** touch hot surfaces without using heat-protective gloves. To avoid burns, use extreme caution when removing hot accessories or disposing of hot grease.
- **Do not** immerse cord, plug or any parts of Air Fryer Toaster Oven in water or other liquid to prevent against electrical hazard.
- To avoid potential hazards, please do not put the product next to or used by children.
- **Do not** operate any appliance with a damaged cord or plug. If the appliance is dropped or damaged, please replace the product.
- To avoid potential injury, do not use accessories or attachments not recommended for the unit.
- **Do not** use outdoors.
- **Do not** let the cord hang over the edge of a surface where the potential of child or pet interaction is present.
- **Do not** place on or near a hot gas or electric burner.
- **Do not** use this appliance for other than intended use.
- Extreme caution should be exercised when using containers constructed of materials other than metal or glass in the Air Fryer Toaster Oven.
- **Do not** store any materials other than manufacturer's recommended accessories in this appliance when not in use.
- **Do not** place any of the following materials in this appliance: cardboard, plastic, paper, or anything similar.
- Oversized foods and utensils must not be inserted in an Air Fryer Toaster Oven as they may involve a risk of fire or electric shock.
- **Do not** use this Air Fryer Toaster Oven for any purpose other than as described in this manual.

IMPORTANT SAFEGUARDS

- A fire may occur if the appliance is covered or touching flammable materials such as curtains, draperies or walls when in operation.
- Do not store any items on top of the appliance when in operation.
- **Do not** clean with metal scouring pads. Pieces can break off the pad and touch electrical parts, involving a risk of electric shock.
- **Do not** clean with acidic substances. Discoloration of the surfaces may occur.
- **Warning:** To avoid possibility of fire, **Never** leave the appliance unattended during use. Use recommended temperature settings for all function.
- **Do not** rest cooking utensils or baking dishes on glass door.
- **Do not** operate your appliance in an appliance garage or under a wall cabinet. When storing in an appliance garage, always unplug the unit from the electrical outlet.
- Check if the voltage indicated on the appliance corresponds to the local main voltage before connecting the appliance.
- This appliance is not intended for use by persons (including children) with reduced physical, sensory or mental capabilities, or lack of experience and knowledge, unless they have been given supervision or instruction concerning use of the appliance by a person responsible for their safety.
- Children should be supervised to ensure that they do not play with the appliance.

FOR HOUSEHOLD USE ONLY
SAVE THESE INSTRUCTIONS

GETTING TO KNOW YOUR AIR FRYER TOASTER OVEN

MAIN COMPONENTS

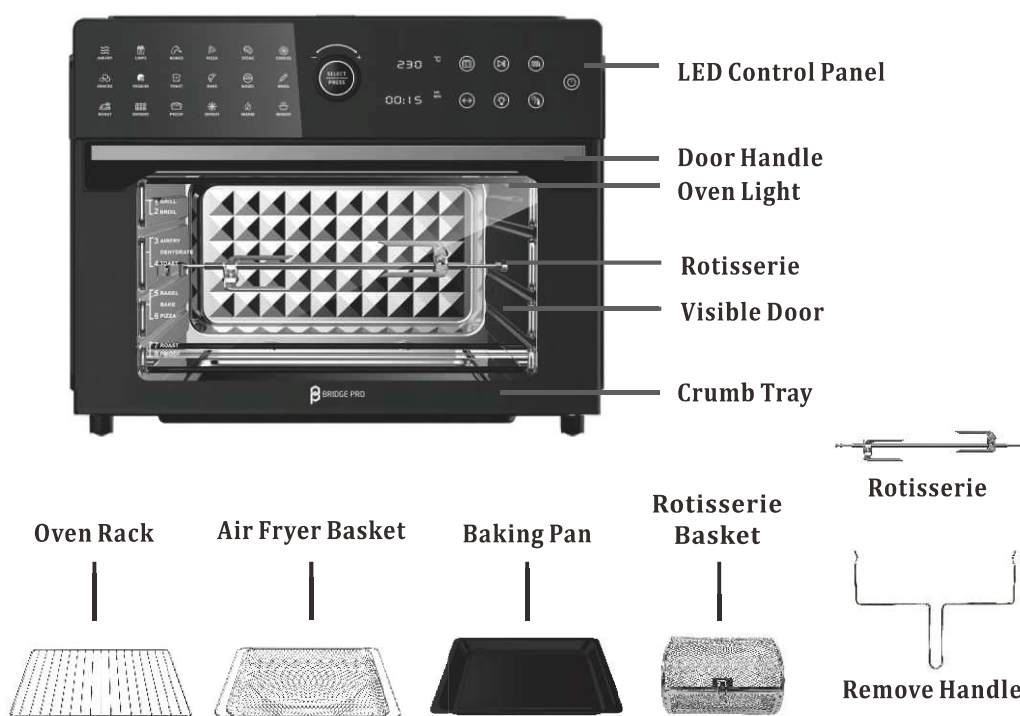

Oven Rack : Used for meat, bread, pizza etc.

Air Fryer Basket : Use the Air Fryer Basket in conjunction with the Air Fry function to optimize your cooking results. Used for fries, chicken wings, onion etc. It also could be used as the dehydrate basket.

Baking Pan : Baking pan coated with anti-stick and black.

Rotisserie : Used for chicken, turkey, meat.

Remove Handle : Used to remove the rotisserie from the oven.

Crumb tray: Used for the crumbs of food.

Rotisserie Basket: Used for granular foods such as beans and chestnuts.

FEATURES

By using all new 360° HOT AIR CIRCULATION technology, The Air Fryer Toaster Oven can offer you more delicious and healthier cuisine.

DOOR SENSOR

If the door is opened during cooking, the cooking will pause and the

light will turn on. The panel will show . When the door is closed, the light will turn off and resume cooking. Please make sure to keep the oven door closed during cooking.

TECHNICAL SPECIFICATIONS

Voltage	Power	Frequency	Capacity
220V-240V	1800W	50Hz	30L

LED Control Panel

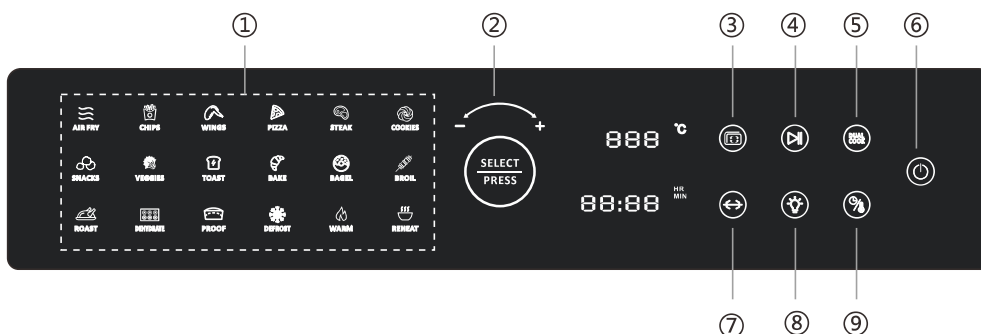

① AirFryer Toaster Oven Functions Overview

PRESET	DEFAULT TEMPERATURE	DEFAULT TIME	TEMP RANGE	TIME RANGE
AIR FRY	200°C	10MINS	90-230°C	Up to 2 HOURS
CHIPS	230°C	18MINS	90-230°C	Up to 2 HOURS
WINGS	230°C	18MINS	90-230°C	Up to 2 HOURS
PIZZA	230°C	11MINS	90-230°C	Up to 2 HOURS
STEAK	230°C	7MINS	90-230°C	Up to 2 HOURS
COOKIES	180°C	15MINS	90-230°C	Up to 2 HOURS
SNACKS	200°C	18MINS	90-230°C	Up to 2 HOURS
VEGGIES	230°C	15MINS	90-230°C	Up to 2 HOURS
TOAST			1~7	1~7MINS
BAKE	175°C	25MINS	90-230°C	Up to 2 HOURS
BAGEL	230°C	13MINS	90-230°C	Up to 2 HOURS
BROIL	230°C	10MINS	90-230°C	Up to 2 HOURS

LED Control Panel

PRESET	DEFAULT TEMPERATURE	DEFAULT TIME	TEMP RANGE	TIME RANGE
ROAST	200°C	30MINS	90-230°C	Up to 2 HOURS
DEHYDRATE	60°C	5HOURS	30-80°C	1-12 HOURS
PROOF	34°C	45MINS	30-40°C	Up to 8 HOURS
DEFROST	50°C	20MINS	30-80°C	Up to 2 HOURS
WARM	50°C	4HOURS	30-120°C	Up to 8 HOURS
REHEAT	95°C	5MINS	90-230°C	Up to 2 HOURS

The above default data are for reference only, the user can adjust the desired temperature and time as required.



You can select the menus by rotating the menu knob, to choose the next menu by rotating it clockwise, to choose the last menu by rotating it counterclockwise, after select the menu, press the menu button to begin the cooking.



After selecting a program and adjusting the temperature, touch "PREHEAT" icon to preheat the Air Fryer Toaster Oven. (No need to touch the "START/PAUSE" icon to start the preheat program. After preheating, the oven will beep 5 times and "Add food" will be showed on the display.)



Touch "START/PAUSE" icon to start or stop the program.

LED Control Panel

⑤ DUAL COOK

Advanced dual function cooking technology allows you to program your Air Fryer Oven to start cooking with one preset, then automatically transition to a second preset for a perfect cook on any meal. For example, put a breadcrumb-topped casserole in the oven, set it to bake then broil, and it will cook through with a golden crisp topping to finish. Just set it and forget it. Enjoy your favorite fried food without any extra operation.

⑥ POWER ON/OFF

Touch "POWER ON/OFF" icon to turn the Air Fryer Toaster Oven On/Off.

⑦ ROTISSERIE

It is used to cook all the food that need to be rotated. After selecting the desired program and setting the temperature/time, touch the start icon to start cooking and then touch the rotisserie icon.

⑧ LIGHT SWITCH

Touch "LIGHT" icon to turn the oven light On/Off. (Without any operation after 5 minutes, the light will turn off automatically. It will turn on again when you touch.)

⑨ TIME/TEMPERATURE SWITCHICON

Touch TEMP/TIME icon to enter the mode of temperature and time.

BEFORE USING YOUR AIR FRYER TOASTER OVEN

- 1** Remove all packaging around and inside the oven.

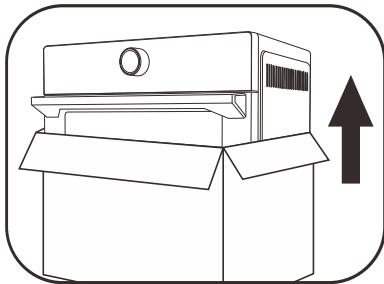

- 2** Place on a stable, level, heat-resistant surface, away from anything that can be damaged by heat. Keep at least 110 mm distance between the electrical outlet and the wall, furniture, etc.

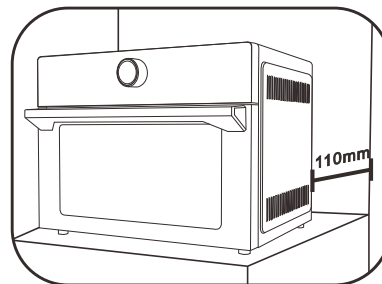

- 3** Remove the protective film from the control panel. (This film is to protect the panel, you can tear it off or keep it.)

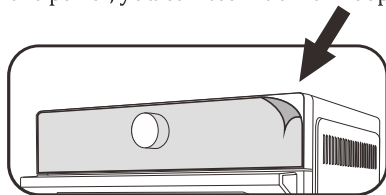

- 4** Wash all accessories and clean the interior of the Air Fryer Toaster Oven. Dry and place accessories back in oven.

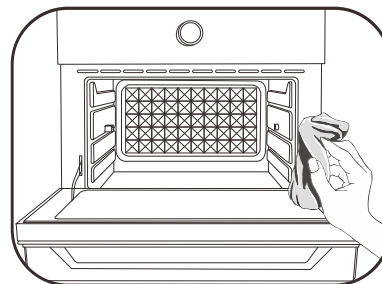

- 5** Before use, ensure that the power and outlet meet the requirements to operate this product (input power requirements).

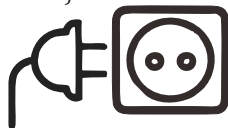

- 6** Upon first use, it is necessary to run the oven for 18 minutes at the highest temperature (230°C) in order to sterilize and remove any manufacturing odor. The Air fryer Toaster Oven may emit an odor or smoke due to the heater's protective film.

OPERATION GUIDE

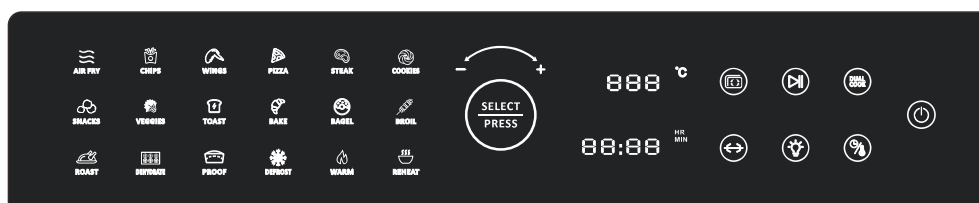

1

Plug in, touch the POWER ON/OFF icon to turn on the Air Fryer Toaster Oven, screen will illuminate and "AIR FRY" icon will blink.



Rotate the menu knob to choose the menus you want, and the default temperature and time will show on the display, users can adjust the temperature and time as described by touching till or flashes, rotating the menu knob, and then press the menu button to begin the cooking.

Note: The temperature on the "Toast" function cannot be adjusted. Touch the time duration for level 1~level 7 of the toast.

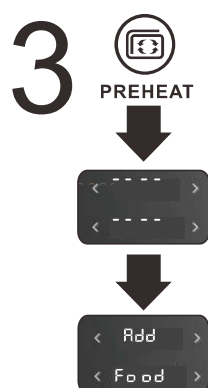

Touch the "PREHEAT" icon in order to preheat the Air Fryer Toaster Oven. When the internal temperature reaches 150°C, the "Add Food" signal will appear. (After preheating, put the food in oven and close the door, the program will start cooking automatically.)

Note: The Toast, Dehydrate, Proof, Defrost, Reheat and Warm programs do not require preheating

OPERATION GUIDE

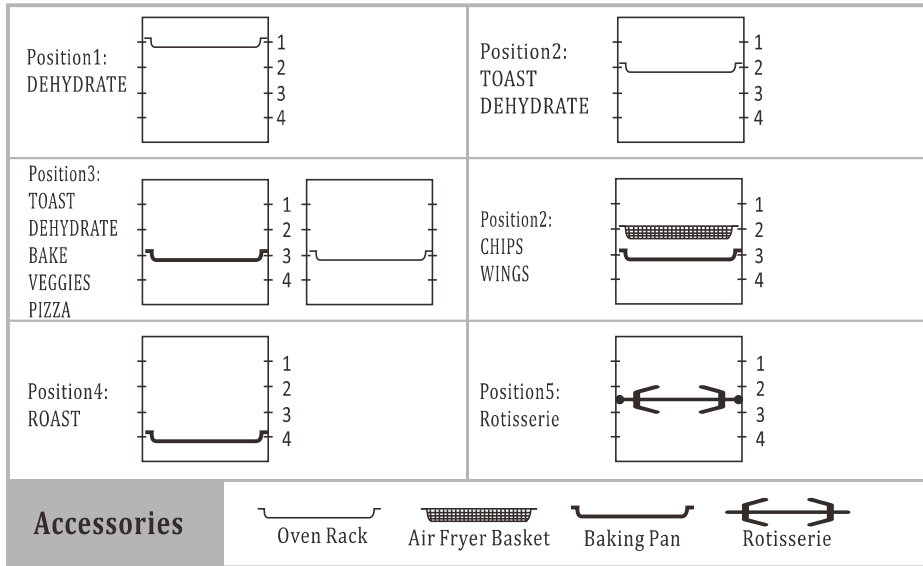

Note: When cooking fatty foods (e.g. chicken wings) with the oven rack, air fryer basket or rotisserie, place the baking pan in the slot underneath in order to prevent oil from dripping on to the stainless-steel heater.

4 Accessories position

Insert the accessories with food into the desired position then close the door. There are four groove positions, use the above rack position diagrams to place the accessories.

Note: If you need to use the rotisserie, fix the food and place it in the Air Fryer Oven.

5 START/PAUSE

If you skip the preheat function of step 3, please touch the START/PAUSE icon to begin cooking, and the display will show the timer counting down. When cooking is done, the oven will beep 5 times, the display will show "END", and all menu icons will light up.

Note: To use the rotisserie, touch the rotisserie icon after touching START/PAUSE icon.

End

Note: The display will continue to show "END" until the menu icon is pressed. After cooking is complete, the fan will continue to run for 4 minutes in order to properly cool the appliance.

DUAL COOK

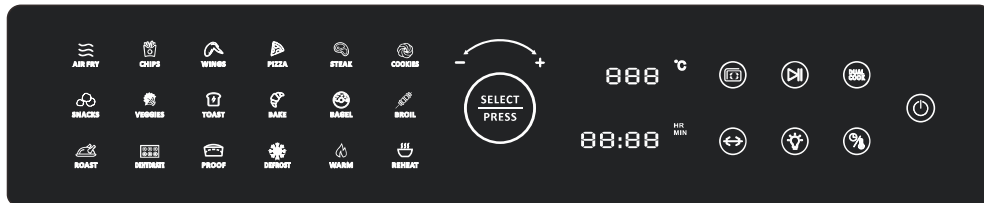

1

Plug in, touch the POWER ON/OFF to turn on the Air Fryer Toaster Oven, screen will illuminate and "AIR FRY" icon will blink.

Eg:





First step



Second step



2 Dual Cook

Touch the DUAL COOK icon, five programs AIR FRY / BAKE / BROIL / ROAST / WARM will illuminate, rotate the menu knob "  " to select the first program needed, "e.g. AIR FRY", and the selected "AIR FRY" will flash (the other four programs will illuminate), then touch the  to select  icon to adjust the desired temperature, then touch  to select  icon to adjust the desired time, finally touch the menu icon to confirm the first program AIR FRY. The remaining four icons will illuminate, repeat the above operations to adjust the second program

Note: If you want to cancel the DUALCOOK function, you can touch the START/PAUSE icon, and then touch the DUALCOOK icon to return to the general menu.

DUAL COOK

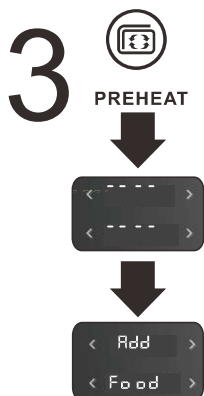

Touch the "PREHEAT" icon in order to preheat the Air Fryer Toaster Oven. When the internal temperature reaches 300°F, the "Add Food" signal will appear. (After preheating, put the food in oven and close the door, the program will start cooking automatically).



Insert the accessories with food into the desired position then close the door. There are four groove positions, use the above rack position diagrams to place the accessories.

Note: If you need to use the rotisserie, fix the food and place it in the Air Fryer Oven.



If you skip the preheat function of step 3, please touch the START/PAUSE icon to begin cooking, and the display will show the timer counting down, the selected first program will be on for a long time, and the selected second program will not be displayed until the first program is completed. When cooking is done, the oven will beep 5 times, the display will show "END", and all menu icons will light up.

Note: To use the rotisserie, touch the rotisserie icon after touching START/PAUSE icon.

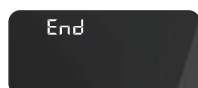

Note: The display will continue to show "END" until the menu icon is pressed. After cooking the fan will continue to run for 4 minutes in order to properly cool the appliance.

COOKING FUNCTIONS QUICK REFERENCE CHART

FUNCTION	PREHEAT	Suggested Amount of Food	Suggested Accessory	Suggested Rack Position
AIR FRY	Yes	base on the food you select	Air Fryer Basket	2
CHIPS	Yes	550g	Air Fryer Basket	2
WINGS	Yes	1038g(28pcs)	Air Fryer Basket	2
PIZZA	Yes	13 inches	Baking Pan or Oven Rack	3
STEAK	Yes	190 g	Baking Pan or Oven Rack	2
COOKIES	Yes	base on the food you select	Baking Pan	2
SNACKS	Yes		Baking Pan or Oven Rack	3
VEGGIES	Yes		Baking Pan or Air Fryer Basket	3
TOAST	No	6pcs	Oven Rack	2or3
BAKE	Yes	base on the food you select	Baking Pan or Oven Rack	3
BAGEL	Yes		Baking Pan or Air Fryer Basket	2
BROIL	Yes		Baking Pan or Oven Rack	2
ROAST	Yes		Baking Pan or Rotisserie	4 or Rotisserie position

COOKING FUNCTIONS QUICK REFERENCE CHART

FUNCTION	PREHEAT	Suggested Amount of Food	Suggested Accessory	Suggested Rack Position
DEHYDRATE	No	base on the food you select	Air Fryer Basket	1 or 2 or 3
PROOF	No		Baking Pan	3
DEFROST	No		Baking Pan	2
REHEAT	No		Oven Rack	3
WARM	No		Baking Pan	2

DUAL COOK FUNCTIONS QUICK REFERENCE CHART

FUNCTION 1	FUNCTION 2	PREHEAT	Suggested Amount of Food	Suggested Accessory	Suggested Rack Position
AIR FRY	WARM	Yes	Base on the food you select	Air Fryer Basket	2
BAKE	BROIL	Yes	Base on the food you select	Baking Pan or Oven Rack	3
AIR FRY	WARM	Yes	Base on the food you select	Baking Pan or Rotisserie Fork	4 or Rotisserie fork position
ROAST	AIR FRY	Yes	Base on the food you select	Baking Pan or Rotisserie Fork	4 or Rotisserie fork position
AIR FRY	BROIL	Yes	Base on the food you select	Air Fryer Basket or Oven Rack	2 or 3

It is a normal occurrence that some moisture may occur on the oven door during the cooking process. We would like to recommend you to preheat the Air Fryer Toaster Oven before cooking.

REPLACING THE LIGHT

ATTENTION: Be sure to unplug the Air Fryer Toaster Oven and allow it to cool completely before replacing the oven light.

SPECIFICATION: 25W halogen bulb

1. Rotate the light cover clockwise to remove it.

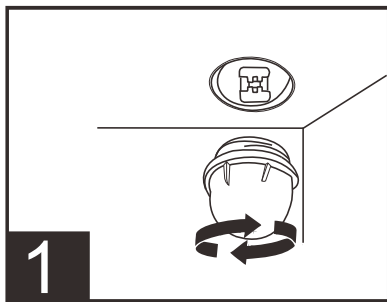

2. Remove the used bulb by pulling it directly.

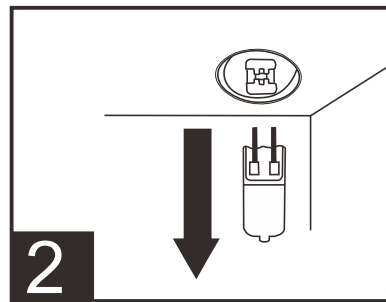

3. Insert the new bulb

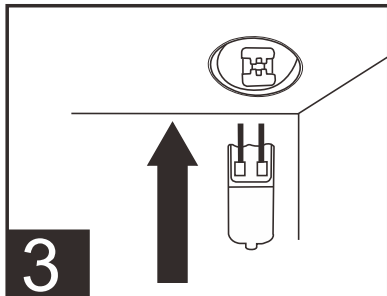

4. Rotate the light cover counterclockwise to tighten it.

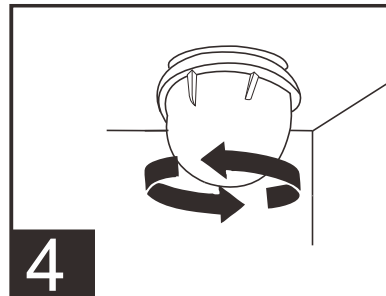

DISASSEMBLING THE INNER GLASS DOOR FOR CLEANING

Attention: Be sure to cool down the glass door completely before disassemble it.

1. Users can turn on the screw counterclockwise by screwdriver.
2. User can use the silicone suction cup to suck up the glass, and then take out the glass with hands.
3. After cleaning and drying the glass, users put the glass back and turn the screw clockwise to replace it.

1

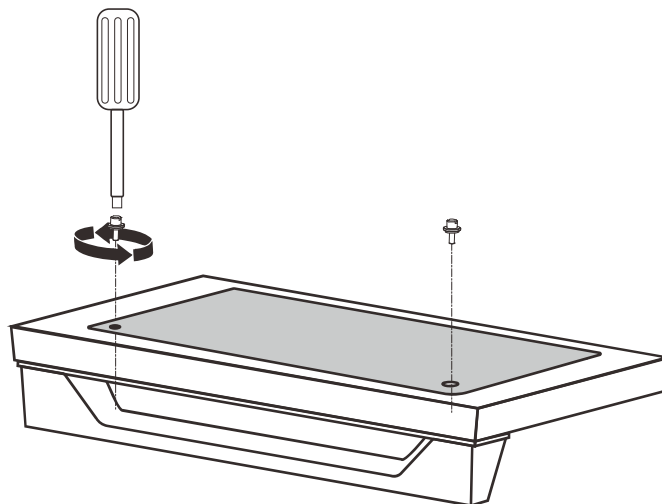

2

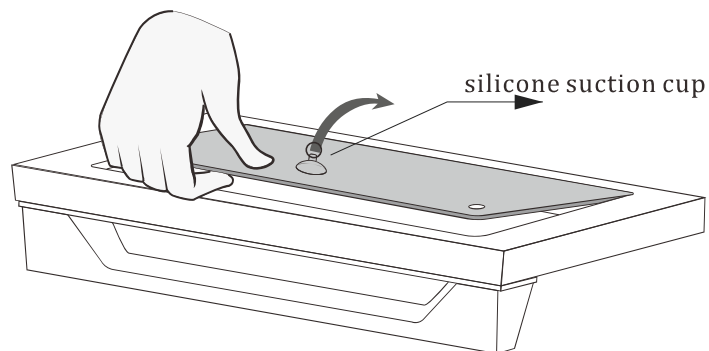

CARE, CLEANING & STORAGE

Before cleaning, remove the power plug from the power outlet. Allow the oven and all accessories to cool completely before disassembling and cleaning.

Cleaning the outer body and door

- Wipe the outer body with a soft, damp sponge. A non-abrasive liquid cleanser or mild spray solution may be used to avoid build-up of stains. Apply the cleanser to the sponge, not the oven's surface, before cleaning.
- To clean the glass door, use a glass cleaner or mild detergent and a soft, damp sponge or soft plastic scouring pad. Do not use an abrasive cleanser or metal scouring pad as these will scratch the oven's surface.
- Wipe the LED screen with a soft, damp cloth. Apply cleanser to the cloth, do not apply cleanser directly on to the LED. Cleaning the LED screen surface with a dry cloth and/or abrasive cleaners may produce scratches.



WARNING: To prevent electrocution, do not immerse the appliance or power cord into water or any other liquid.

Cleaning the interior

- To clean any spattering that may occur while cooking, wipe the walls with a soft, damp sponge. A non-abrasive liquid cleanser or mild spray solution may be used to avoid build-up of stains. Apply the cleanser to the sponge, not the interior, before cleaning.



WARNING: Use extreme caution when cleaning the heating elements. Allow the oven to cool completely, and then gently rub a soft, damp sponge or cloth along the length of the heating element. Do not use any type of cleanser or cleaning agent. Let all surfaces dry thoroughly prior to inserting the power plug into a power outlet and turning the oven on.

Cleaning the crumb tray

- After each use, slide out the crumb tray and discard crumbs. Wipe the tray with a soft, damp sponge. A non-abrasive liquid cleanser or mild spray solution may be used to avoid build-up of stains. Apply the cleanser to the sponge, not the tray, before cleaning. Dry thoroughly.
- To remove the baked-on grease, soak the tray in warm soapy water then wash with a soft sponge or soft plastic scouring pad. Rinse and dry thoroughly.
- Always ensure to re-insert the crumb tray into the oven after cleaning and prior to inserting the power plug into a power outlet and turning the oven on.

Cleaning the Oven rack, baking pan, air fry basket, and remove handle.

- Wash all accessories in warm soapy water with a soft sponge or soft plastic scouring pad. Rinse and dry thoroughly. Do not use abrasive cleansers, metal scouring pads or metal utensils to clean any of the accessories as they may damage the surfaces.
- To extend the life of your accessories, cleaning them with non-abrasive substances is recommended.

Storage

- Ensure the oven and all accessories are clean and dry.
- Ensure the door is closed.
- Store the appliance in an upright position, standing level and on its supporting legs. Do not store appliance when wet or hot. Do not store in a wet or hot environment.

Trouble shooting

Possible Problem	Possible Cause	Solution
The oven does NOT work	The appliance is not plugged in	Make sure the oven is plugged in.
	You have not turned on the oven	Touch the POWER ON/OFF icon to power on
	The door is not closed properly	Make sure the door is closed well.
Steam is coming out from the top of the oven door	You are cooking high moisture content foods	This is normal. The door is vented to release steam created from high-moisture content foods such as frozen breads.
White smoke is coming out of the oven	This is the first time using the oven	This is normal upon first use. We suggest setting the oven to the highest temperature and letting it run empty from 18-20 minutes.
	You're cooking greasy food	This is normal when cooking greasy foods. This will not affect the cooking process.
	The baking pan, crumb tray, or heaters still contain grease or oil residue from previous use	Ensure each component is properly cleaned after each use.
Dark smoke is coming out of the oven	Food is burning	Immediately turn off the oven, be careful when you take out the food.
The ingredients cooked with the oven are not done	Too much food in the oven at once	Reduce the amount of food in the oven when cooking.
	Setting temperature too low or time too short	Set the temperature higher or time longer.
	Choose the incorrect function	Make sure you cook with the proper function.

Possible Problem	Possible Cause	Solution
Foods are cooked unevenly	Ingredients are stacked or close to each other during cooking	Make sure food and ingredients are spread out evenly.
	Baking pan, Air Fry basket or oven rack position is not adjusted	Adjust oven inserts into the proper position. Take caution as these components may be hot.
Foods are not crispy after Air Frying	Ingredients with high moisture	Spraying or brushing a small amount of oil on food evenly can increase crispiness.
Display shows Error Code "E1"	There is a short circuit in the temperature monitor	Remove the power cord from the power outlet. Contact Customer Support.
Display shows Error Code "E2"	The temperature monitor or heaters is inoperative	Remove the power cord from the power outlet, reconnect and operate again. If it cannot be solved, then Contact Customer Support.
Top heating elements not glowing bright orange	Strong fan above top elements blows air onto top elements to dim the glow.	No action needed. Oven is working as expected.
There is no recipe book or cooking book.	None provided.	Consider books on recipe ideas, cooking tips from Susanna Unsworth: Easy Air Fryer Todd English: The Air fryer Cookbook
Toaster not working	Incorrect processing	Rotate Menu to TOAST. Oven is preset to 1 degree and 1 minute. Push down Menu to start the toast operation. Adjust the temp or time up to 7 minutes and vary the toast colour to your desired taste.

Terms & Condition

BridgePro Management Ltd ("BPM").

Limited Warranty:

This product is guaranteed for 12 months from the date of original purchase.

This guarantee is valid in the UK only.

If any defect arises due to faulty materials or workmanship, the faulty products must be returned to the place of purchase. Refund or replacement is at the discretion of the retailer.

The following conditions apply:

- The product must be returned to the retailer with proof of purchase or a receipt.
- The product must be installed and used in accordance with the instructions contained in this instruction guide.
- It must be used only for domestic purposes.
- It does not cover wear and tear, damage, misuse or consumable parts.
- The product has limited liability for incidental or consequential loss or damage.

To validate your warranty, please visit www.bgepro.com/support/warranty/ and register with us online. Warranty is only valid with proof of purchase or receipt.

This product warranty is available to consumers only.

You are a consumer if you purchased the product at retail for personal, family, or household use.

Except as otherwise stated under applicable law, this warranty is not available to retailers or other commercial purchasers and owners.

This product warranty is void if the product is used for situations other than a single-family household use or subjected to any voltage and wave forms other than as specified in this instruction manual (e.g. 220V-50Hz).

Transportation charges:

Transportation charges for products under this warranty, subject to repair or replacement, shall be borne by the purchaser.

Conditions:

Service centres or retail stores do not have the right to alter, modify, or in any way change the terms and conditions of this warranty.

Warranty registration is not necessary but is encouraged to validate product warranty.

About your warranty:

Most warranty repairs or replacements are handled routinely but sometimes requests for warranty services may not be appropriate, e.g. warranty services would NOT apply if the product damage occurred because of misuse, lack of routine maintenance, shipping, handling, 3rd party warehousing, or improper installation. Similarly, warranty is void if the serial number on the product has been removed or the product has been altered or modified.

Normal wear: This warranty does not cover normal wear of any parts or damage resulting from any of the following negligent use or misuse of the product:

- Improper voltage or current,
- Use contrary to the operation instructions,
- Deviation from the instructions regarding storage and transportation, or
- Repair or alteration by any 3rd party.

This warranty does not cover Acts of God such as fire, flood, hurricanes, and tornados.

BPM shall not be liable for any incidental or consequential damages by the breach of any express or implied warranty.

Except to the extent prohibited by applicable law any implied warranty of merchantability or fitness for the particular purpose is limited in duration of this warranty.

Warm Tip

- ① **NOTE:** When cooking greasy foods (e.g. chicken wings) with the oven rack, air fryer basket or rotisserie spit and fork, place baking pan underneath can prevent oil from dripping on the bottom heating element.

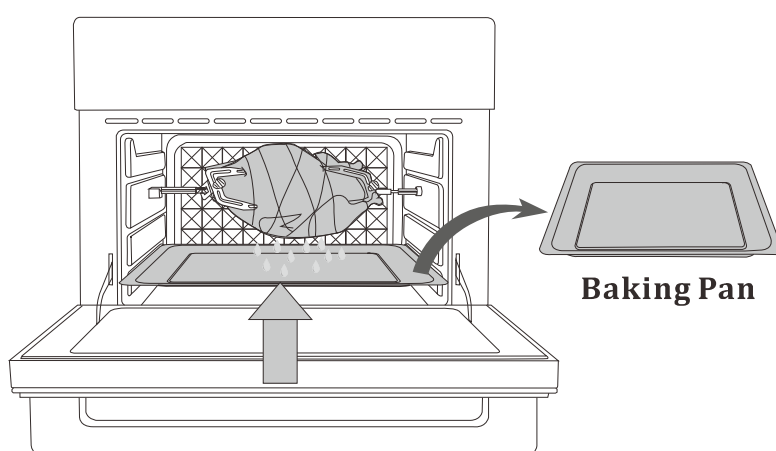

- ② **NOTE:** After cooking greasy foods (e.g. chicken wings), there will be oil stains on the back plate and side plate of the oven, please clean it in time to avoid excessive accumulation of oil stains and leakage to the bottom of the machine (If the oil stain is not cleaned in time, it will not come off). Use fresh lemon and hot water to remove grease stains from the baking dish and let them soak for 30 minutes before washing

Warm Tip

- ③ **NOTE:** The upper heating elements will not turn red during operation of the oven and this is a normal occurrence. The wattage of the top two heating elements differs from the bottom two to maintain an appropriate oven chamber temperature.

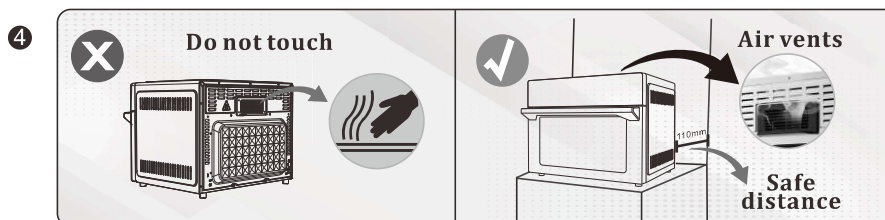
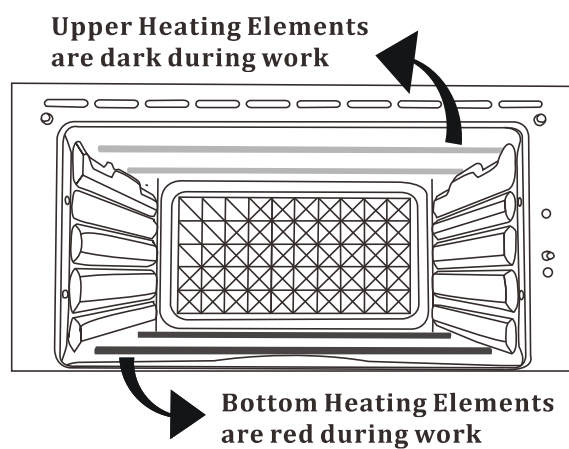

⚠ CAUTION

- ▲ Hot air and smoke may be emitted from the back of the oven during cooking. This is normal as the specially designed vent helps to remove excess moisture for crispy results.
- ▲ Do not position the vent towards any area that can be directly touched by humans to prevent burns.
- ▲ Please ensure a minimum distance of 110mm between the oven and the wall when placing on a countertop.
- ▲ The oven is designed for baking high-temperature products. When operating the oven, exercise caution to avoid placing it near curtains and other flammable objects.

Warm Tip

Environmental Protection First

Your appliance has been designed to run for many years. However, when you decide to replace it, remember to think about how you can contribute to protecting the environment.



This marking indicates that your appliance should not be disposed of with other household wastes throughout the UK or the EU. To prevent possible harm to the environment or human health from uncontrolled waste disposal, recycle this appliance responsibly to promote the sustainable reuse of material resources. Your appliance contains valuable materials which can be recovered or recycled. Leave it at a local civic waste collection point.

Cleaning the oven interior, crumb tray, oven rack, baking pan To clean any spattering that may occur while cooking, wipe the walls with a soft, damp sponge.

A non-abrasive liquid cleanser or mild spray solution may be used to avoid build-up of stains.

Apply the cleanser to the sponge, not the interior, before cleaning.



WARNING:

Do not use hard cleaning tools

Do not use strong cleaners

This will damage the surface of the product and cause corrosion and rust.



NOTE
