

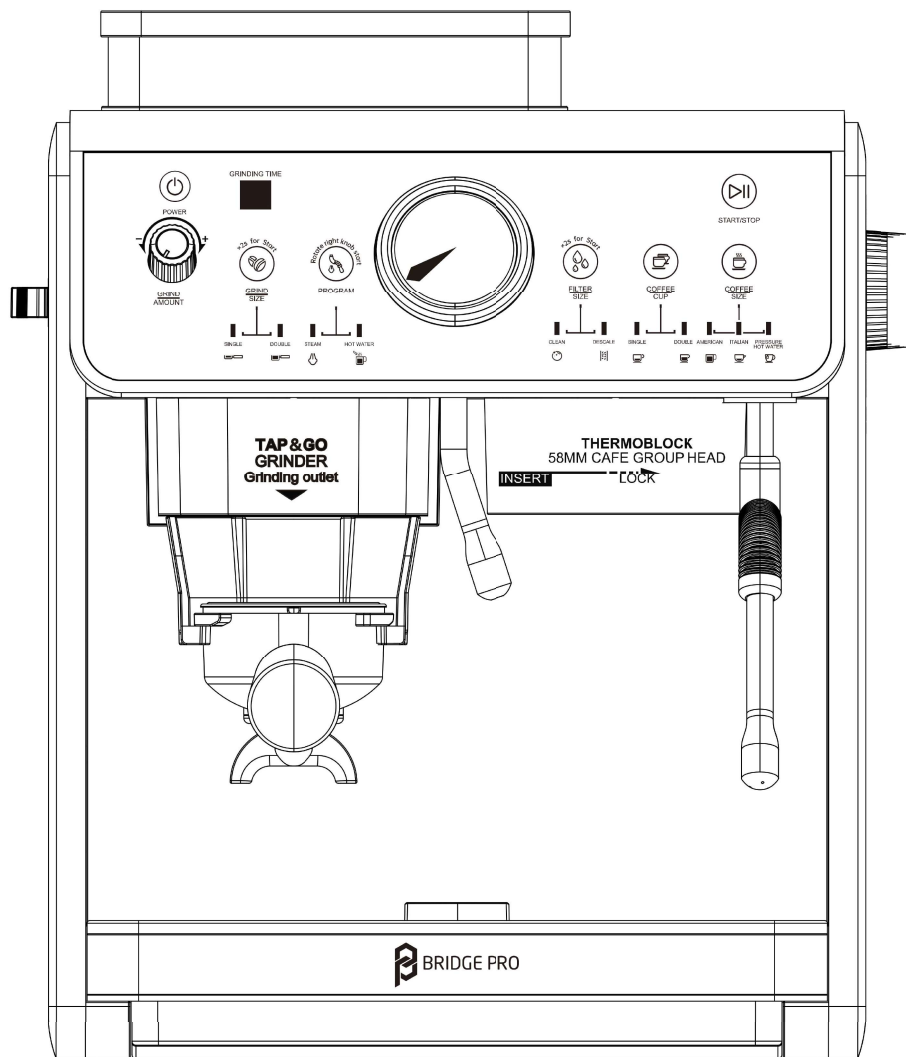

## Semi-Professional Espresso Coffee Machine



**Model: 543313**

*Serial number located of the back of the unit.*

Please keep this instruction manual.

Please read the manual before using the coffee machine.

## Contents

Important Safeguards .....	4
Safety Precautions: Warnings .....	4
High Pressure .....	5
High Temperature .....	5
Product Introduction: Getting to know your coffee machine.....	6
Main Components .....	6
Control Panel and Functions Overview.....	6
Accessories Description .....	7
Description of Coffee Brewing Head, Steam Pipe, and Hot Water Pipe .....	7
Accessories Instructions: Power Cleaning Brush .....	8
Accessories Instructions: Blade Disc Cleaning Brush.....	8
Accessories Instructions: Powder Hammer .....	8
Accessories Instructions: Cleaning the Brewing Head, Hot Water N and Nozzle Head.....	9
Unboxing Your Coffee Machine .....	9
Steps to take Before Using Coffee Machine.....	9
Preparing for First Time Use: Install Water Tank .....	9
Preparing for First Time Use: Install the Bean Box .....	10
Preparing for First Time Use: Clean the Brewing Head, High-Pressure Funnel, and Filter Screen .....	10
Preparing for First Time Use: Cleaning the Hot Water Nozzle.....	11
Preparing for First Time Use: Clean the Steam Pipe .....	11
Operations Guide: Make Espresso while the Machine is in Warm State (after preheating) .....	12
Operations Guide: Milk Foam Function.....	13
Espresso Extraction Guidelines.....	14
Espresso Extraction Guideline: Making American Coffee – Single Cup (Warm State).....	14
Controlling Hot Water Flow Rate for Single Cup American Coffee .....	15
Espresso extraction guideline: Making a American coffee – Double cup (Warm State).....	16
Controlling hot water flow rate for double cup American coffee.....	16
Continuous Hot Water Discharge Function.....	17
Restore Factory Setting for American Single/Double Cup Hot Water Flow Rate (Warm State) .....	18
American Single Cup Flow Factory Setting .....	18
American Double Cup Flow Factory Setting .....	18
Operating Instructions .....	18
First Use of Your Coffee Machine.....	18
Coffee Making Function.....	19
Default Cup Size for Italian Single Cup Coffee.....	20
Default Cup Size for Italian Double Cup Coffee.....	21
User Defined Espresso Cup Quantity.....	21
Customized Settings for Italian Single Cup Flow Rate.....	21
Italian Double Cup Flow Customization Settings .....	22
Restore Default Cup Size for Italian Single/Double Coffee Separately.....	23
Nozzle Function: Steaming .....	24
Nozzle Fnction for Discharging Hot Water (Warm State) .....	24

Operating Instructions .....	25
Set Coffee Beans Extraction Temperature .....	25
Temperature Set Mode .....	25
Temperature Setting Display Code Definition .....	26
Water Tank Shortage Prompt .....	26
Standby Mode .....	26
Instructions for Grinding Coffee Beans Function .....	27
Double Cup Grinding .....	27
Single Cup Grinding .....	28
Instructions for Grinding Beans Function .....	29
Instructions for Grinding Beans Function: A Customized Memory Function for Grinding Bean Time .....	30
Customized Memory for Single Cup Grinding Time .....	30
Customized Memory for Double Cup Grinding Time .....	30
The Default Time Setting for Restoring Single and Double Cup Grinding Beans .....	31
Coffee Powder Grinding Recommendations .....	31
Restore Factory Settings .....	31
Maintenance and cleaning .....	32
Cleaning and Maintenance .....	32
Cleaning Coffee Machine Outlets .....	32
Cleaning Function .....	33
Scale Removal Function .....	34
Preparation for Descaling .....	35
Descaling Mode .....	35
Daily Maintenance of Bean Grinder .....	37
Cleaning Method for Bean Grinder .....	37
Grinding Anomaly Resolution .....	38
Other Maintenance: .....	39
Clean the Drain Tray .....	39
Environmental protection treatment .....	39
Food Hygiene Labeling .....	39
Troubleshooting .....	40
Fault Codes .....	41
Warranty .....	42
Register Warranty .....	42
Discount on Future Purchases .....	42
Terms & Condition of Purchase .....	43
Notes .....	44

---

# Important Safeguards

## Safety Precautions: Warnings

Before using steam pipes, please observe the following basic safety precautions:

1. Please read this manual carefully before use.
2. Check if the voltage you are using matches the rated voltage of the product.
3. To prevent electric shock and fire, do not immerse the power cord or plug in water or other liquids.
4. Use the coffee machine only in the presence of an adult, adults must monitor use. Children should not approach or use the coffee machine.
5. Unplug the coffee machine before using or cleaning it. Allow the coffee machine system to cool down before installing or removing internal components or cleaning.
6. If the power cord is damaged, in order to avoid danger, it must be replaced by a qualified professional.
7. If the coffee machine malfunctions or is unable to function properly within warranty period, contact the manufacturer at [info@bgepro.com](mailto:info@bgepro.com) for support, or for a designated maintenance provider for testing or repair, or for other guidance. If outside the warranty period, repair should be completed by a qualified professional.
8. Do not use components from non-designated manufacturers. This will cause harm or potential danger to users.
9. Do not use steam pipes outdoors in the open air.
10. Do not let the power cord hang on the edge of the table or make contact with hot surfaces.
11. Do not place the coffee machine on or near a gas tank or oven.
12. Do not use the coffee machine for other purposes other than that stated in this document. Do not use it in a dry environment.
13. Fill the water tank with clean cold water and do not add mineral water, milk, or other liquid beverages to the tank.
14. When unplugging the plug please grab the insulated part of the plug and unplug the power cord, do not directly pull on the power cord.
15. When making coffee certain parts of the coffee machine are very hot and should not be directly touched. Limit contact to handles or knobs provided on the on or for the coffee machine.
16. Children should be monitored to ensure that they do not play with this appliance or its accessories.
17. The operating or storage temperature of the coffee machine should be greater than 0°C. It is prohibited to use the coffee machine when the water in the water tank freezes.
18. Do not use the coffee machine in environments with high temperatures, strong magnetic fields, and/or humid air.
19. When used by individuals with physical and sensory disabilities, and a lack of relevant experience and knowledge, it is necessary that a guardian with normal abilities and knowledge of safe operation supervises and provides guidance to user.
20. Children are prohibited from playing with this appliance and its supporting equipment's. Children are prohibited from maintaining this appliance without supervision. Please take good care of this appliance and do not allow children access to it.
21. Ensure that the power socket used to connect the coffee machine and accessories power cord plug is reliably grounded.
22. It is prohibited to use power sources other than the nominal rated voltage range and frequency of this coffee machine to supply power to this coffee machine.
23. Do not use this appliance when the water tank is empty.
24. This coffee machine is suitable for household / domestic use with the designated power supply of this coffee machine, such as:
  - Home
  - In shops, offices, and other indoor workplaces
  - Hotel or inn rooms, motels, and other indoor living spaces
25. Cleaning the coffee machine, or cleaning and maintaining the coffee machine accessories should be done by responsible and able bodied adults.
26. This coffee machine must not be submerged or flushed directly.
27. Caution is needed during removal and cleaning of the cutterhead, emptying the bean box, and general cleaning.
28. Disconnect the power supply of the entire machine before replacing accessories or touching moving parts.
29. Save this manual and the accompanying warranty card.

### High Pressure

To prevent hot steam and hot water from scalding the body or causing other personal injuries, as well as to prevent damage to this product, do not remove the water tank or funnel components when using this coffee machine to brew coffee or foam milk. Before you remove the funnel assembly and brew a cup of coffee, please check whether the coffee machine is in a warm state. If you want to add more water to the water tank, please press the power switch button to turn off (all indicator lights are off) to ensure that the coffee machine is in standby mode. Remove the water tank and add water before putting it back in place. Before extracting coffee, please ensure that the high-pressure funnel has been rotated to the designated position and locked to avoid loosening due to pressure during use, which can easily cause injury.

### High Temperature

When this coffee machine is working, do not touch the funnel or steam nozzle with your hands or other parts of your body to prevent burns. At all times, it is prohibited to touch the metal parts of the steam pipe with hands or other parts of the body. Only the silicone sleeve on the steam pipe can be touched to adjust the position of the steam pipe to prevent burns.

<b>Model / Parts #:</b>	<b>543313</b>
<b>Rated voltage:</b>	<b>220-240V</b>
<b>Rated frequency:</b>	<b>50Hz</b>
<b>Rated power:</b>	<b>2,800W</b>



**Do not immerse this product in liquid.**

# Product Introduction: Getting to know your coffee machine

## Main Components

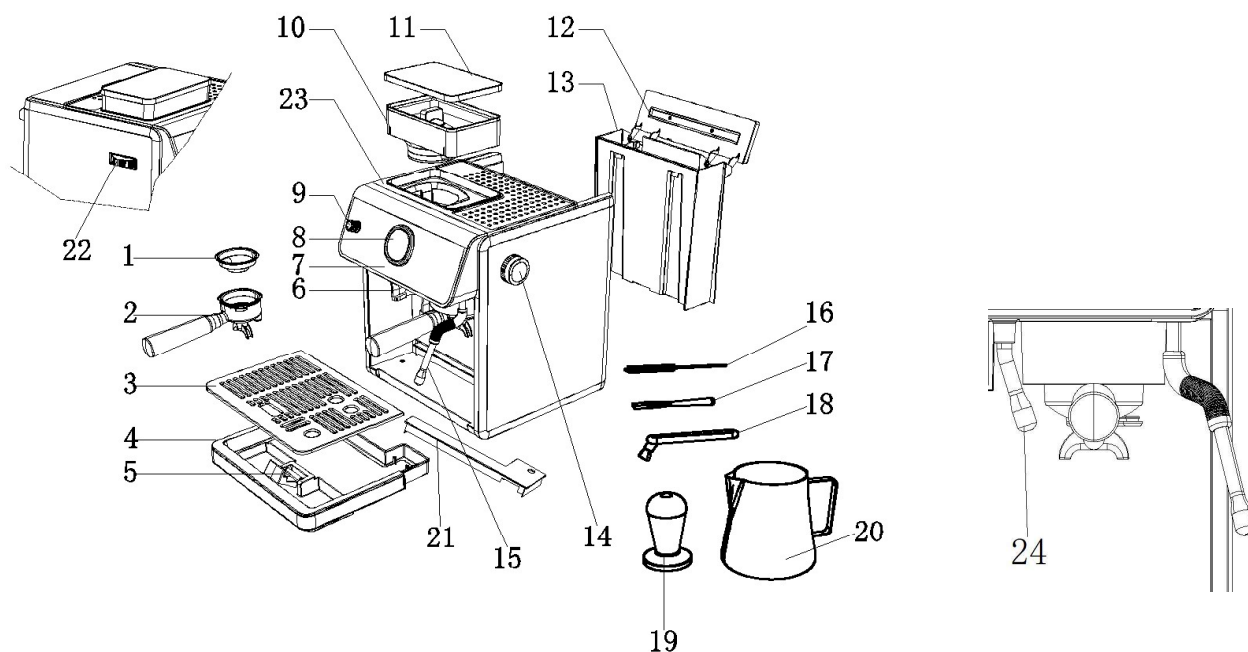

1. Single cup filter screen	9. Adjusting knob for grinding time	17. Blade disc cleaning brush
2. High-pressure funnel	10. Bean box	18. Brewing head cleaning brush
3. Cup mat	11. Bean box lid	19. Powder hammer
4. Water pan	12. Water tank cover assembly	20. Latte art pot
5. Buoy	13. Water tank	21. Steam baffle
6. Powder receiving bracket	14. Steam knob	22. Grinding thickness adjustment knob
7. Operations / control panel	15. Stainless steel steam rod / pipe / wand	23. Top cover
8. Pressure gauge	16. Powder cleaning brush	24. Hot water outlet

## Control Panel and Functions Overview

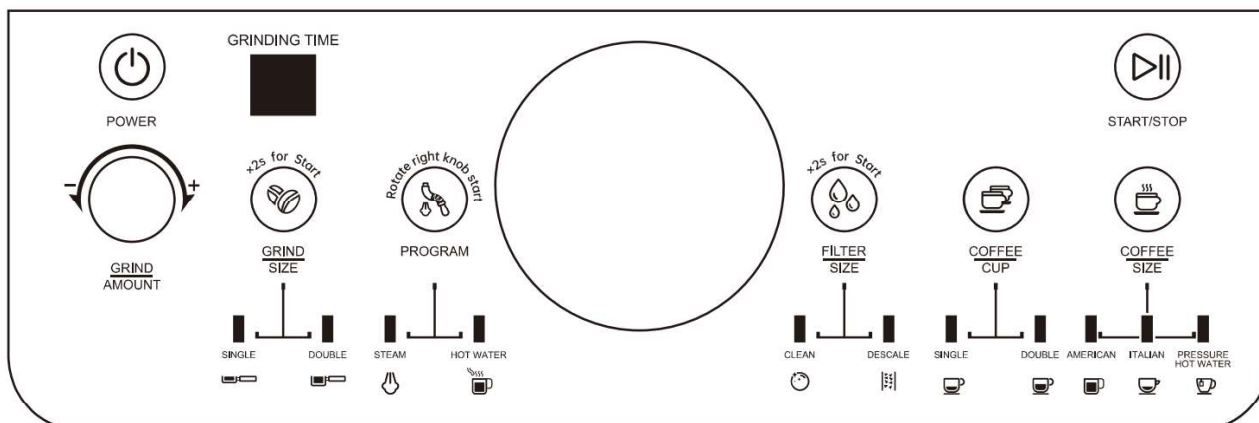

Power switch button.



Grinding time adjustment knob.



Grinding time display.



Grinding capacity selection key is used for the grinding function for selecting single cup grinding or double cup grinding.



Steam and hot water selection button, used for selecting the steam function or hot water function of the nozzle.



Cleaning mode selection button for selecting and activating cleaning or descaling functions.



Coffee capacity selection button for single or double cup brewing of Italian or American coffee.



Coffee type selection button for selecting American coffee, Italian coffee, or hot water functions.



Start/stop button, used to start or stop American coffee, Italian Coffee, or hot water functions.

### Accessories Description

This product is equipped with accessories such as the Powder Cleaning Brush, Blade Disc Cleaning Brush, Brewing Head Cleaning Brush, Latte Art Pot, Powder Hammer. A single and double cup filter screen is provided in a separate carton within the main box. After receiving the product, the user will find a central coffee machine package that also contains small boxes holding the auxiliary tools for brewing coffee.

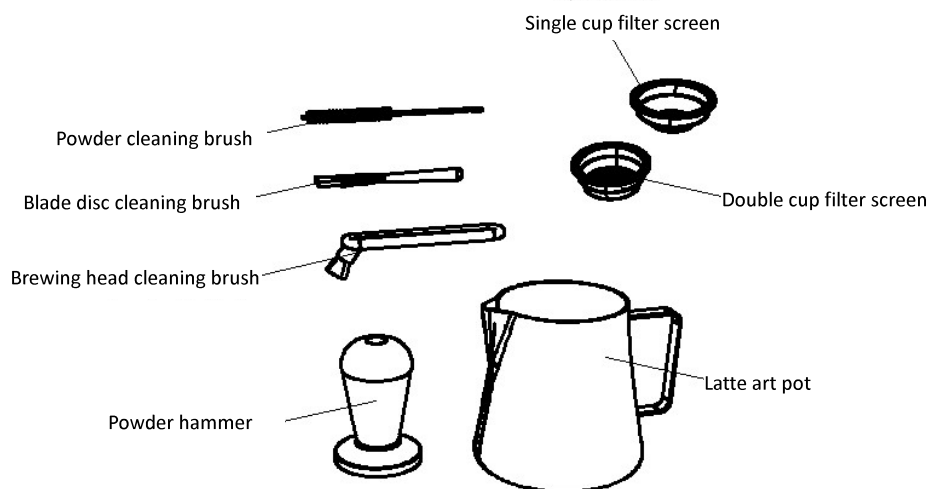

### Description of Coffee Brewing Head, Steam Pipe, and Hot Water Pipe

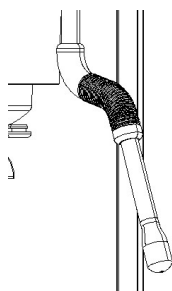

Steam wand: used for foaming milk foam.

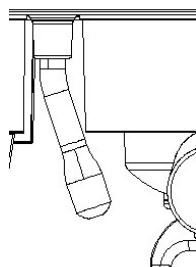

Hot water pipe: used for dispensing hot water, or American coffee mixed with hot water.

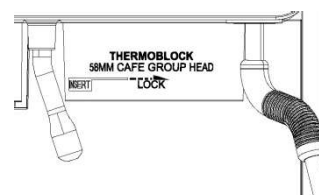

Brewing head: used for making espresso.

### Accessories Instructions: Power Cleaning Brush

Mainly used to clean the powder channel from the outside.



Powder cleaning brush

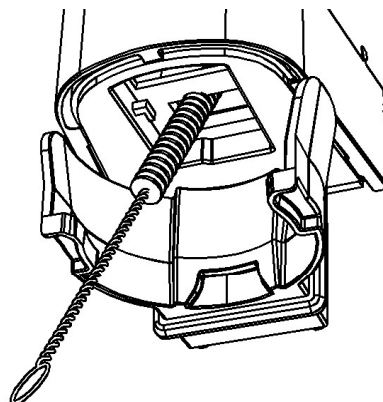

Clean the powder outlet channel

### Accessories Instructions: Blade Disc Cleaning Brush

Used to clean the grinding system. After removing the grinding wheel you can use a cleaning brush to clean the powder chamber and outlet channel.



Blade disc  
cleaning brush.

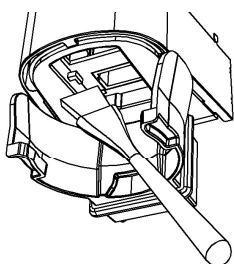

Clean the plasma head and powder  
discharge channel.

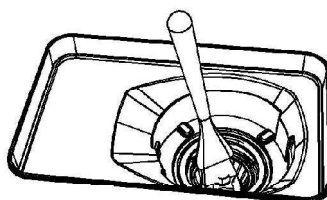

Clean the grinding  
chamber and powder  
outlet.

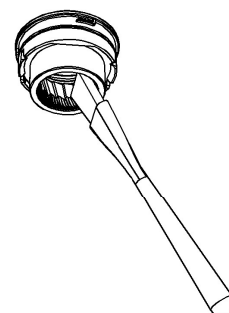

Clean the grinding blade  
disc.

Note: If the powder output is slow  
and powder dispersion appears,  
clean the plasma head according to  
this diagram.

### Accessories Instructions: Powder Hammer

The powder hammer is mainly used for leveling and compacting coffee powder.

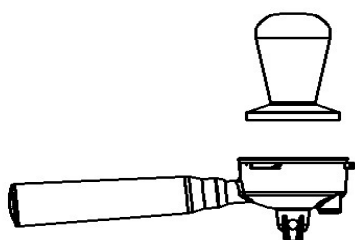

Press down the coffee  
powder.

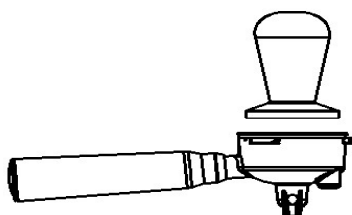

When the edge of the powder hammer is flush with the filter  
mouth it represents the most suitable powder quantity.

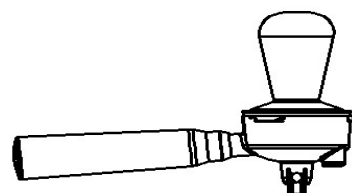



## Accessories Instructions: Cleaning the Brewing Head, Hot Water N and Nozzle Head

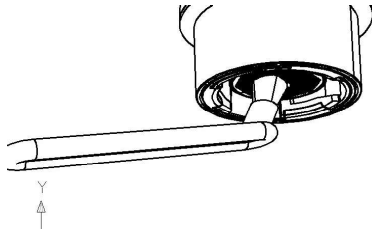

1. Clean the brewing head.

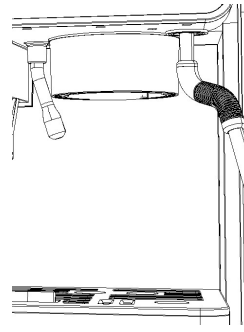

2. Clean the hot water nozzle and nozzle head with a damp cloth.

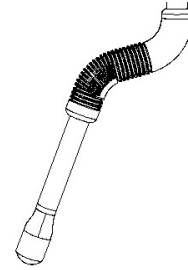

## Unboxing Your Coffee Machine

### Steps to take Before Using Coffee Machine

1. Remove all labels and packaging materials attached to the coffee machine, inspect and ensure that all accessories are complete and undamaged.
2. Use warm water and mild detergent to clean components and accessories (water tank, handle, filter screen, and drain pan), and rinse thoroughly with clean water. Thoroughly dry the outer shell and coffee bean box with a soft wet cloth.

**Warning: Do not immerse the casing, power cord, or power plug in liquids.**

### Preparing for First Time Use: Install Water Tank

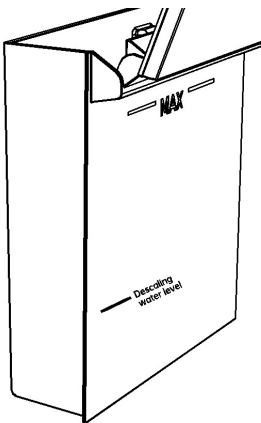

i. Pour in pure drinking water.

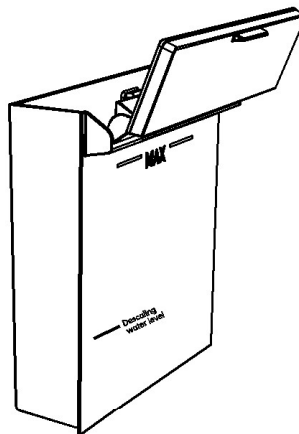

ii. Fill the water tank with clean water. The water level should not exceed the maximum (MAX) water level line of the water tank.

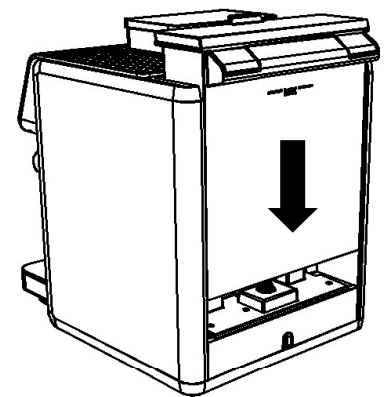

iii. Install the water tank completely.

Note: It is recommended to use drinking water with low hardness or purified water. It is not recommended to use water with high hardness.

## Preparing for First Time Use: Install the Bean Box

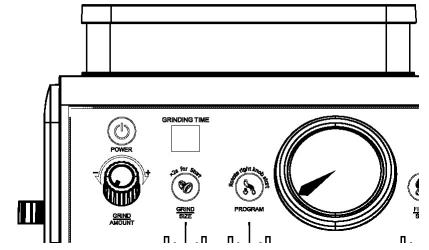
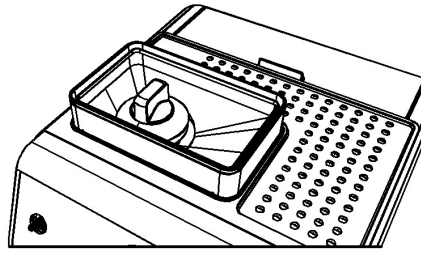
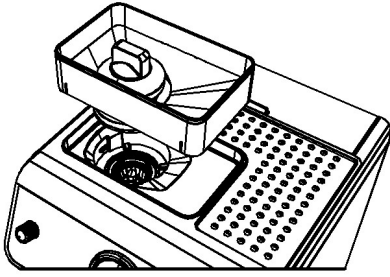

Place the bean box in the installation position on the top cover of the machine.

Turn the knob in the bean box clockwise to the locked position.

Bean box installation completed.

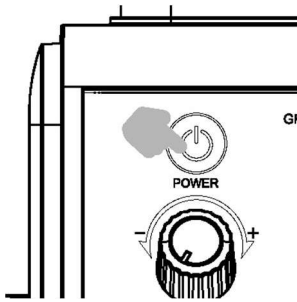

After the entire machine is powered on, press the power on button to start the machine. The machine will enter the preheating state until warm state is reached.

## Preparing for First Time Use: Clean the Brewing Head, High-Pressure Funnel, and Filter Screen

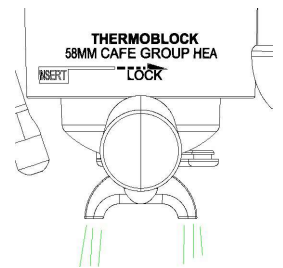
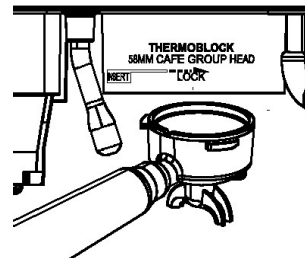
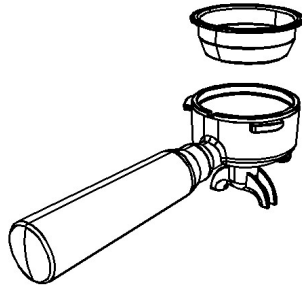
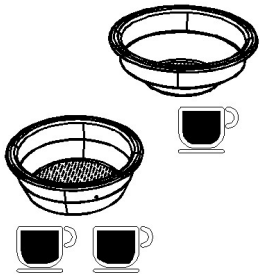

1. Select a single or double cup filter screen.

2. Install the filter screen into the handle funnel.

3. Turn the handle counterclockwise to lock the funnel.

4. Turn the funnel counterclockwise to lock in position.

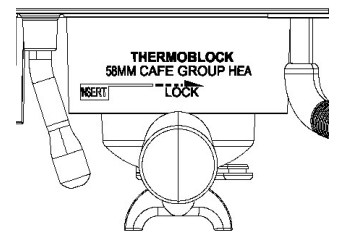
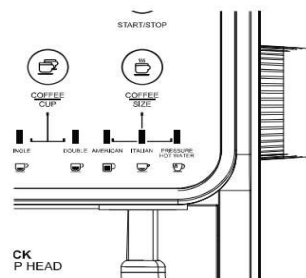
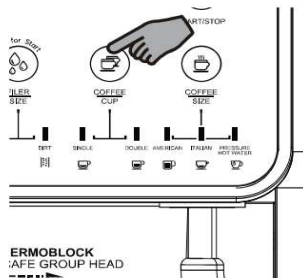
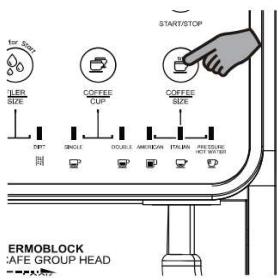

5. Press the coffee type key to select Italian coffee.

6. Press the coffee capacity key to select single or double cup coffee.

7. Press the start button.

8. Clean the brewing head with warm water. Or perform a cleaning function.

## Preparing for First Time Use: Cleaning the Hot Water Nozzle

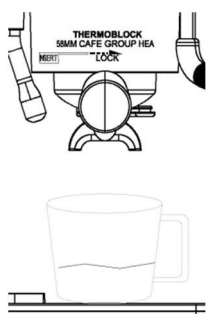

1. Place the cup on the coaster and under the hot water nozzle.

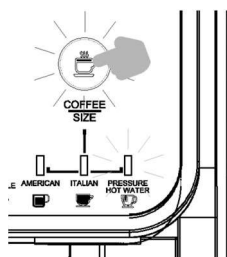

2. Press the coffee type button to select hot water.

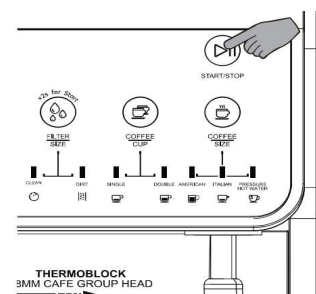

3. Press the start button and the coffee machine will automatically produce hot water.

**Note:** To discharge hot water, use a water cup with a capacity of 350-400ml to prevent hot water from splashing out.

## Preparing for First Time Use: Clean the Steam Pipe

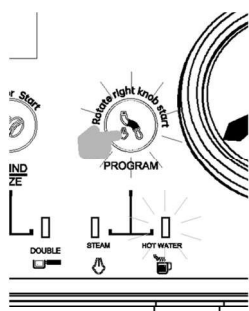

1. Press the nozzle function button to select hot water.



2. Using a cup to collect water.

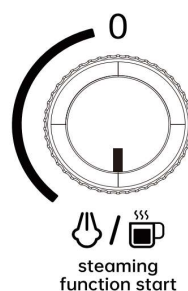

3. Turn the steam/hot water knob to the steam/hot water position and start the hot water function to produce an appropriate amount of hot water.

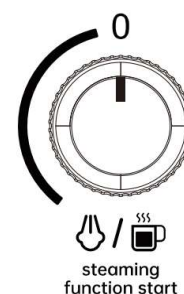

4. Turn the steam/hot water knob to the 0 position to end cleaning.

**Note:** When extracting coffee ensure that the funnel has been rotated counterclockwise into the correct position and locked as shown in the following images.

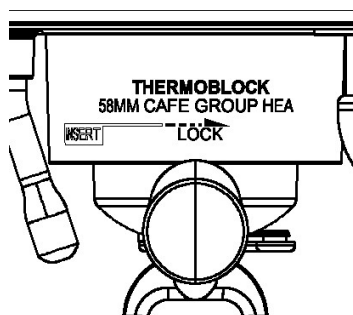
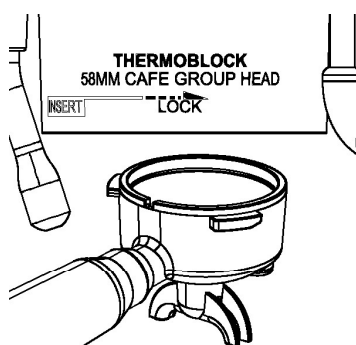

**Operations Guide: Make Espresso while the Machine is in Warm State (after preheating)**

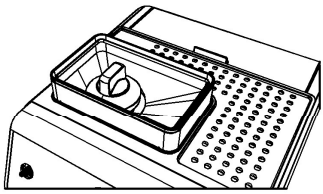

1. Pour in fresh coffee beans.

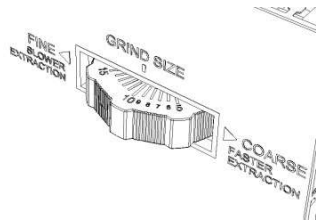

2. Adjust the micro gear on demand to your preferred grinding state – 1-Fine, 10-Coarse.

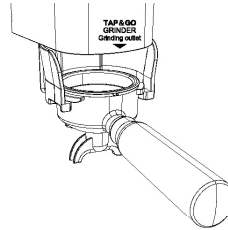

3. Place the high-pressure funnel on the powder receiving bracket.

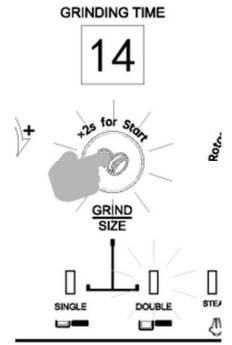

4. Press the grinding capacity key to select single or double cup grinding, and long press the grinding capacity key to start grinding beans.

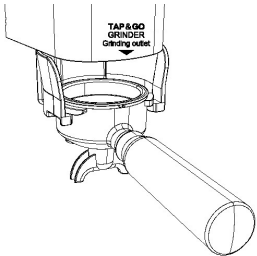

5. Grounded coffee beans automatically dispenses and stops after reaching the set grinding amount.



6. Use a powder hammer to flatten the coffee powder first and then press it down tightly.



7. Wipe off the coffee powder that overflows around the funnel mouth.

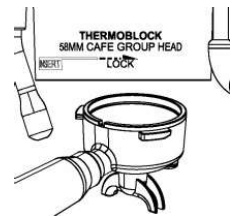

8. Rotate the funnel counterclockwise to the locked position.

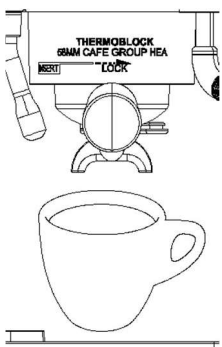

9. Place coffee cup.

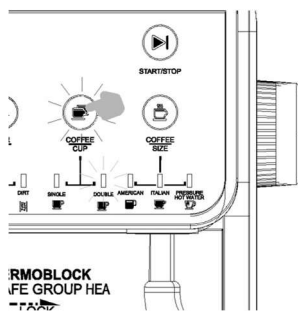

10. Choose to make single or double espresso cups (select single or double cup coffee based on the grinding amount of beans previously selected and the selected single and double cup filter screen).

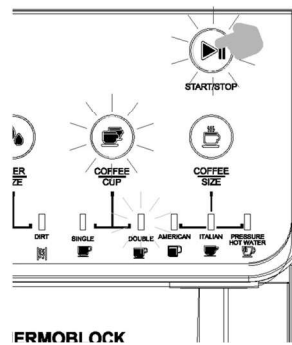

11. Press the start button to start brewing coffee.

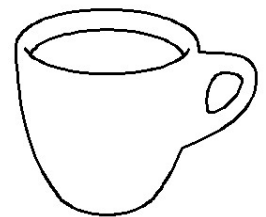

12. Wait for brewed coffee automatic extraction to complete.

## Operations Guide: Milk Foam Function

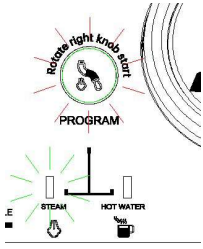

1. Steam preheating completed.

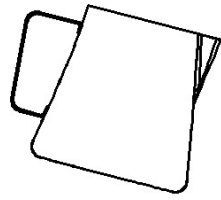

2. Pour in 1/2 cup of fresh chilled milk.

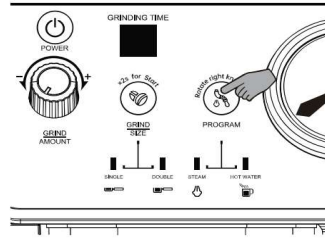

3. Press the nozzle function button to select the steam function.

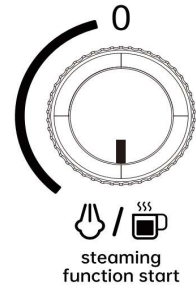

4. Turn the steam / hot water knob to the steam position.

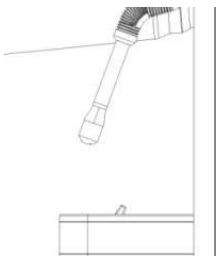

5. Release steam for a period of time to preheat the nozzle pipeline.

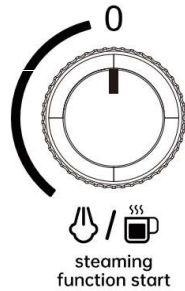

6 Turn the steam / hot water knob to the 0 position to end steam execution.

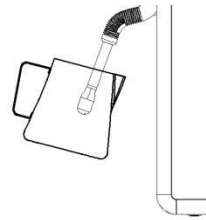

7. Insert the steam rod into the milk in the milk container and adjust the angle of the steam rod.

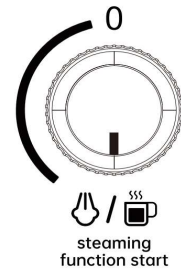

8. Turn the steam/hot water knob to the steam/hot water position.

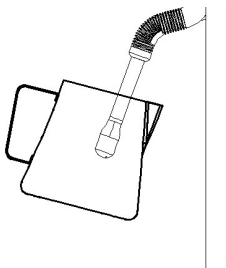

9. Whip the milk foam until the temperature of the milk container is warm/hot, or reaches your desired temperature.

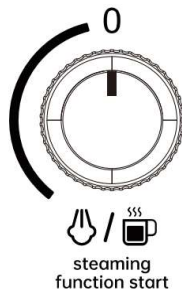

10. Turn the steam/hot water knob to the 0 position to end steam execution.

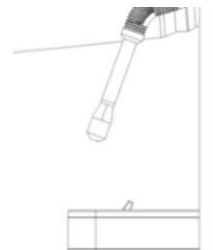

11. Clean the head of the steam rod with a damp cloth.



12. Pour the beaten milk foam into espresso coffee.

## Espresso Extraction Guidelines

Usually, the best tasting coffee needs a balance of acidity, aroma, concentration, and bitterness. Using this coffee machine, you can adjust the grinding amount, thickness, and pressure of coffee powder to brew espresso that suits your taste.

### Espresso Extraction Guideline: Making American Coffee – Single Cup (Warm State)

Making a single cup of American coffee while the coffee system is in warm state.

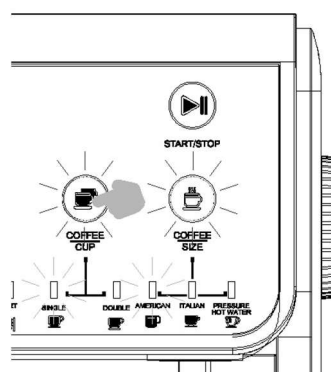

1. Press the coffee type selection button to select American coffee and the American coffee indicator light will come on.

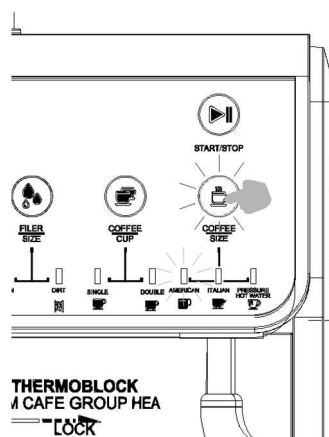

2. Press the coffee capacity button to select a single cup and the single cup indicator light will come on.

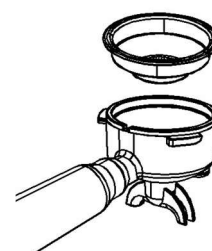

3. Use a single cup filter to press into the funnel.

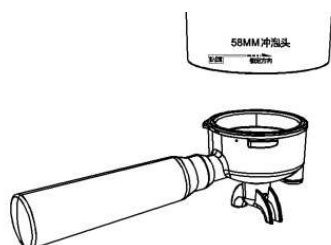

4. Fill approximately 13 grams of coffee powder into a single cup filter and use a powder hammer to flatten, press down tightly.

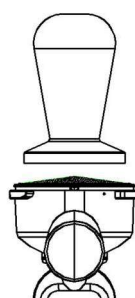

5. Rotate the funnel counterclockwise to the locked position.

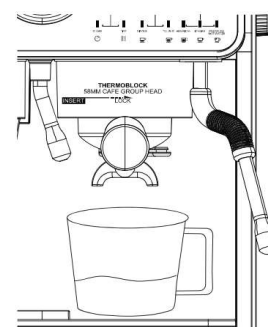

6. Place an American coffee cup aligned with the hot water and coffee outlet.

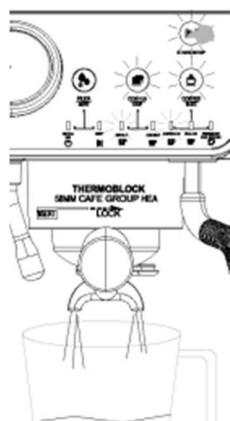

7. Press the start/stop button once and the coffee machine will automatically start producing a single cup of espresso.

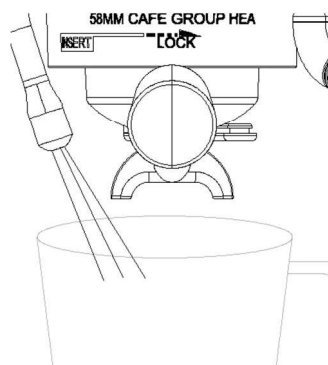

8. The coffee machine automatically discharges the right amount of hot water from the hot water outlet for a single cup of American coffee.

**Note: To make American coffee use a large American coffee cup with a capacity of 350-400ml to prevent coffee from splashing out.**

## Controlling Hot Water Flow Rate for Single Cup American Coffee

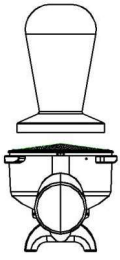

1. Fill approximately 13 grams of coffee powder into a single cup filter and use a powder hammer to flatten and press down tightly.

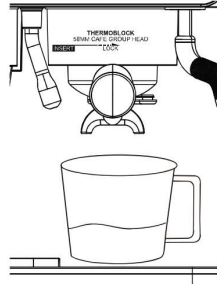

2. Rotate the funnel counterclockwise to the locked position. Place an American coffee cup aligned with the hot water outlet and coffee outlet.

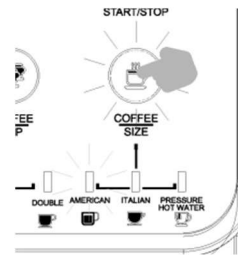

3. Press the coffee type selection button to select American coffee, and the American coffee indicator light will come on.

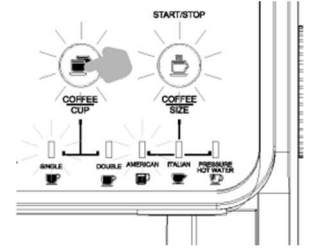

4. Press the coffee capacity selection button to select a single cup and the single cup indicator light will come on.

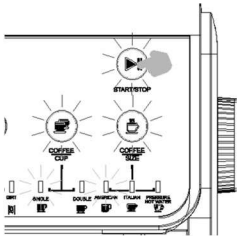

5. Press and hold the coffee type selection button and start button simultaneously.

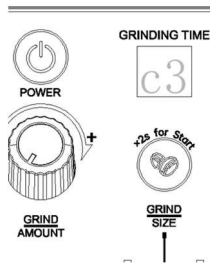

6. The control panel will display C3, the coffee type key indicator, the start/stop key indicator, the single cup indicator, and the American indicator will begin to flash.

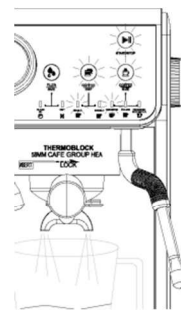

7. The coffee machine starts by automatically producing a single cup of espresso.

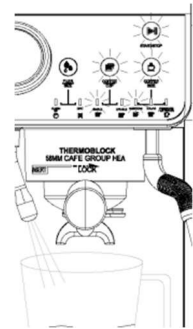

8. The coffee machine automatically releases hot water from the hot water outlet.

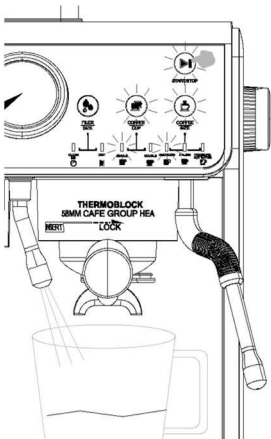

9. When the flow rate reaches your desired hot water volume, press the start/stop button again to stop the coffee machine from dispensing more hot water.

The system will record this volume as your set flow rate for American single cup coffee hot water. When you use the American single cup coffee function again hot water will be discharged to the last set flow rate used.

**Note: Only hot water flow rates between 60 – 120ml are considered valid records for set flow rate.**

## Espresso extraction guideline: Making an American coffee – Double cup (Warm State)

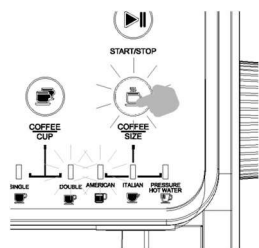

1. Press the coffee type selection button to select American coffee and the American coffee indicator light will come on.

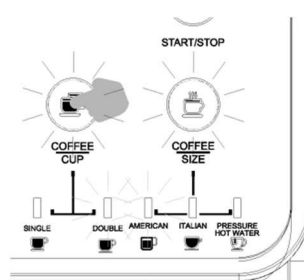

2. Press the coffee capacity selection button to select dual cups and the dual cup indicator light will come on.

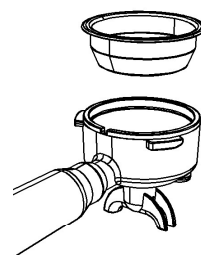

3. Use a single cup filter to press into the funnel.

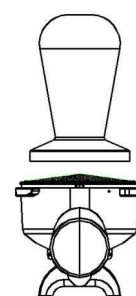

4. Fill approximately 19 grams of coffee powder into a double cup filter and use a powder hammer to flatten, press down tightly.

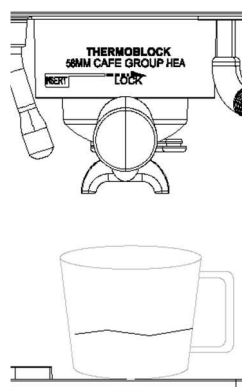

5. Rotate the funnel counterclockwise to the locked position.

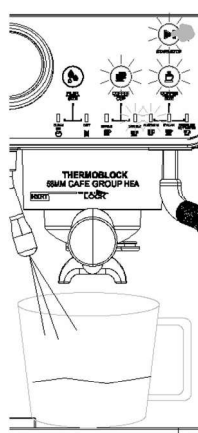

6. Place an American coffee cup aligned with the hot water outlet and coffee outlet.

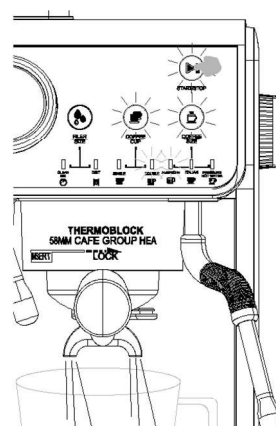

7. Press the start/stop button once, and the coffee machine will automatically start producing double cups amount of espresso.

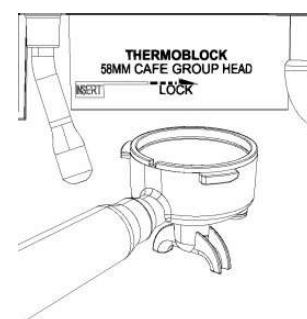

8. The coffee machine automatically discharges the right amount of hot water from the hot water outlet for a double cup of American coffee.

**Note: To make American coffee use a large American coffee cup with a capacity of 350-400ml to prevent coffee from splashing out.**

### Controlling hot water flow rate for double cup American coffee



1. Fill approximately 19 grams of coffee powder into a double cup filter and use a powder hammer to flatten, press down tightly.

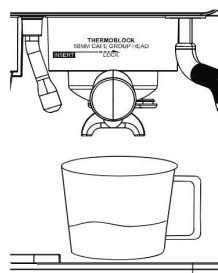

2. Rotate the funnel counterclockwise to the locked position. Place an American coffee cup aligned with the hot water outlet and coffee outlet.

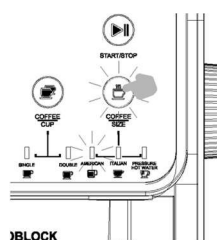

3. Press the coffee type selection button to select American coffee and the American coffee indicator light will come on.

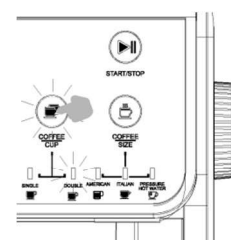

4. Press the coffee capacity selection button to select dual cups and the dual cup indicator light will come on.



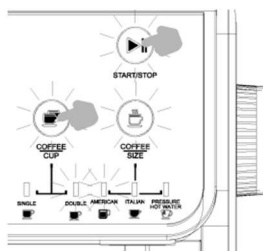

5. Press and hold the coffee type selection button and start button

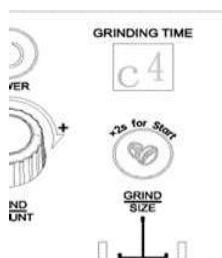

6. The control panel will display C4, the coffee type key indicator, the start/stop key indicator, the single cup indicator, and the American indicator will begin to flash.

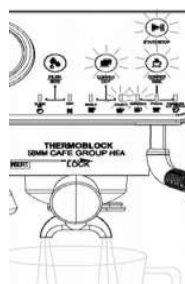

7. The coffee machine starts by automatically producing double cups of espresso first.

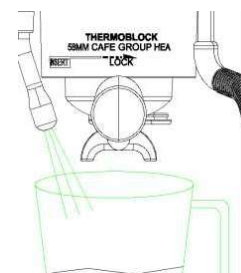

8. The coffee machine automatically releases hot water from the hot water outlet.

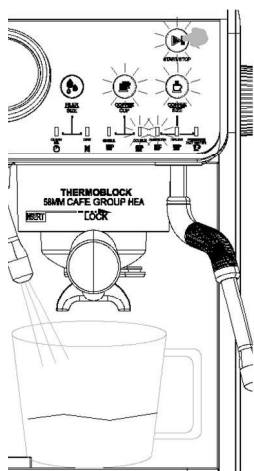

9. When the flow rate reaches your desired hot water volume, press the start/stop button again to stop the coffee machine from dispensing more hot water.

The system will record this volume as your set flow rate for American double cup coffee hot water. When you use the American double cup coffee function again hot water will be discharged to the last set flow rate used.

**Note: Only hot water flow rates between 120 – 240ml are considered valid records for set flow rate.**

### Continuous Hot Water Discharge Function

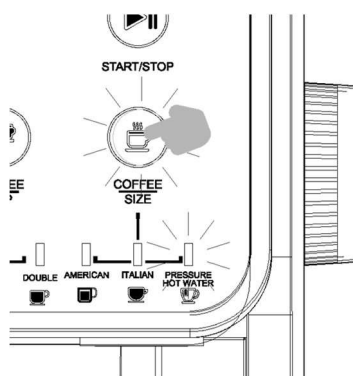

1. Press the coffee type selection button to select the hot water function.

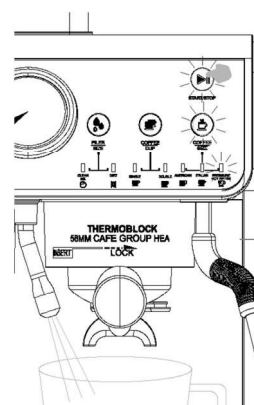

2. Press the start button once, and the coffee machine will start dispensing hot water. The coffee type button indicator light, hot water indicator light, and start button indicator light will flash. When the desired amount of hot water is reached, press the start/stop button once to end the hot water flow.

**Note: Run hot water for a maximum time of 2 minutes. During the process, the hot water flow can be stopped by pressing the start/stop button. Use a large water cup with a capacity of 350-400ml to prevent hot water from splashing out. Approximately 170-225ml of hot water can be produced.**

## Restore Factory Setting for American Single/Double Cup Hot Water Flow Rate (Warm State)

### American Single Cup Flow Factory Setting

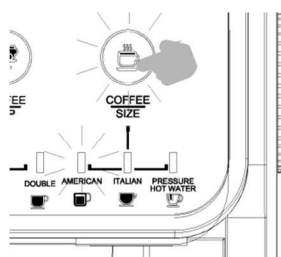

1. Press the coffee type selection button to select American coffee and the American coffee indicator light will come on.

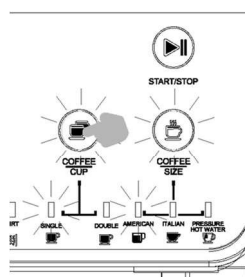

2. Press the coffee capacity selection button to select a single cup and the single cup indicator light will come on.

GRINDING TIME

r3



3. Press and hold the coffee capacity button again. The coffee capacity button indicator light, American coffee indicator light, and single cup indicator light will flash a few times.

The control panel will display r3 several times, and then coffee machine returns to the preheating state.

### American Double Cup Flow Factory Setting

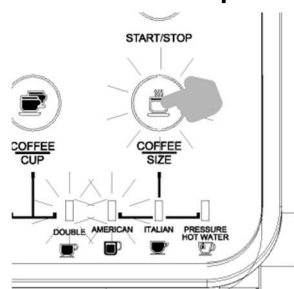

1. Press the coffee type selection button to select American coffee and the American coffee indicator light will come on.

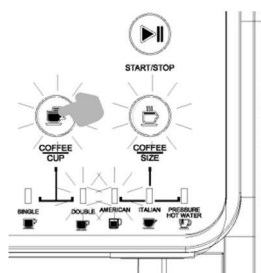

2. Press the coffee capacity selection button to select dual cups and the dual cup indicator light will come on.

GRINDING TIME

r4



3. Press and hold the coffee capacity button again. The coffee capacity button indicator light, American coffee indicator light, and the dual cup indicator light will flash a few times.

The control panel will display r4 several times, and then coffee machine returns to the preheating state.

## Operating Instructions

### First Use of Your Coffee Machine

1. Check and ensure that all accessories are complete and undamaged.
2. Fill the water tank with water, and the water level should not exceed the MAX maximum position.
3. Take the high-pressure funnel (without coffee powder) and align it with the funnel bracket buckle. Rotate counterclockwise to lock the funnel (insert a single or double cup filter screen as needed).
4. Connect the power supply and press the power button to enter the preheating state, until the entire machine is preheated and enters the warm state.



5. Press the **POWER** to select hot water function, turn the steam knob to the steam/hot water position and release an appropriate amount of hot water (please note that the steam pipe needs to be aligned with the water tray or use a cup to collect water to avoid burns).
6. Clean the machine pipeline (please be careful not to place any part of your body under the funnel, please use a cup to collect water to avoid burns).
7. After the water stops flowing out, pour out the water from the drain pan.
8. Thoroughly clean the detachable parts of the entire machine with warm water.

## Coffee Making Function

1. Fill the water tank with clean drinking water, and the water level should not exceed the "MAX " maximum position.



2. Plug in the power supply, all lights and the display panel will come on 2 seconds. Press the **POWER** power button once, and the coffee machine will enter the preheating state (depending on the temperature of each heating boiler).

The specific operations are as follows:

*There are corresponding indicator lights on the function selection button, and corresponding sub function indicator lights below the function selection button. The following are the lighting conditions of the indicator lights in various machine states.*

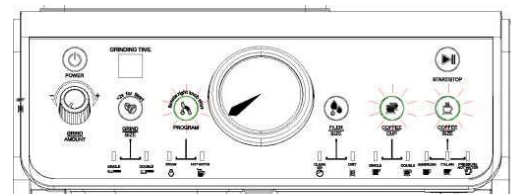
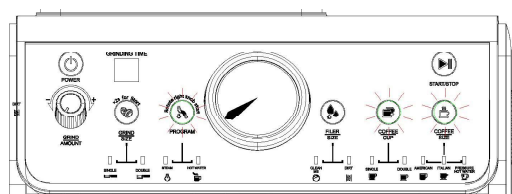
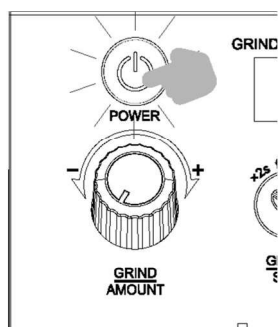

1. Press the power button once.

2. The nozzle function button indicator light flashes in the preheating state of the steam boiler or remains on in the preheating state of the steam boiler

The coffee type button indicator light and coffee capacity button indicator light flash under the preheating state of the coffee boiler.

3. When the indicator light of the nozzle function button lights up, it indicates that the steam boiler of the coffee machine has completed preheating and entered the insulation state.

At this time, steam can be produced. If it is still flashing, the steam boiler of the coffee machine is preheating and needs to wait for the preheating to complete.

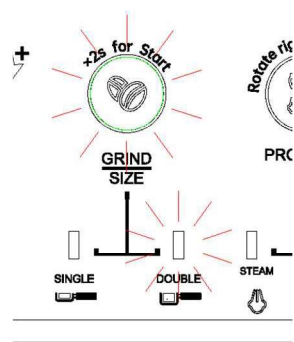
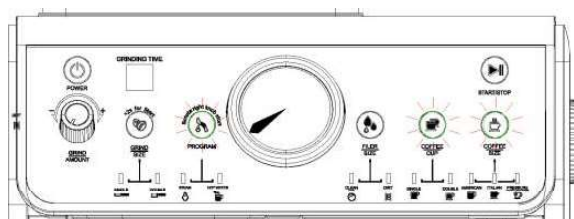

4. When the coffee type indicator light is on, it indicates that the coffee boiler has preheated and entered the insulation state.

At this time, Italian coffee, American coffee, and hot water can be made. If it is still flashing, the coffee boiler is preheating till it reaches warm state.

5. When the coffee machine is installed in place and locked, the grinding capacity key indicator lights up, the grinding single cup or double cup indicator lights up, and the display panel shows the set running time corresponding to the selected grinding cup amount.

When the bean cup is not installed in place or locked, the grinding capacity key indicator, grinding single cup and grinding double cup indicator will flash, and the display panel will show P1.

### Default Cup Size for Italian Single Cup Coffee

In the reheating state, install a single cup filter into a funnel and load about 13 grams of coffee powder. Use a powder hammer to flatten the coffee powder and press it down tightly. Then align the funnel component with the funnel bracket and rotate it counterclockwise to lock it into the funnel bracket. Place the coffee cup on the cup mat.

See the operation below:

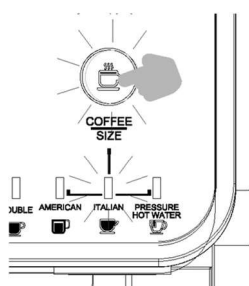

1. Press the coffee type selection button to select Italian coffee.

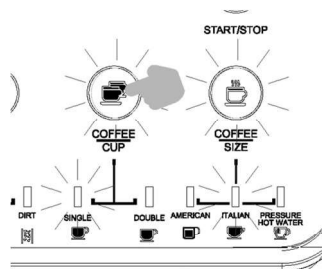

2. Press the coffee capacity selection button to select a single cup.

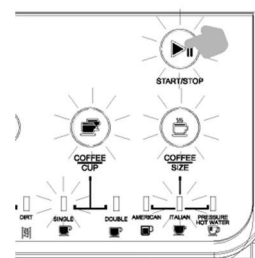

3. Press the start/stop button once, and the coffee machine will enter the single cup coffee brewing function.

At the same time, the start/stop button indicator light, coffee capacity selection button indicator light, Italian coffee indicator light, and single cup indicator light will flash. When the set flow rate is reached (about 30ml), the coffee machine will automatically stop producing coffee, and the single cup coffee function will end. The entire machine will enter the preheating state.

## Default Cup Size for Italian Double Cup Coffee

In the preheating state, install the double cup filter into a funnel, fill it with approximately 19 grams of coffee powder. Use a powder hammer to flatten the coffee powder and press it down tightly. Then align the funnel assembly with the funnel bracket and rotate it counterclockwise to lock it into the funnel bracket. Place the coffee cup on the cup mat. See the operation below:

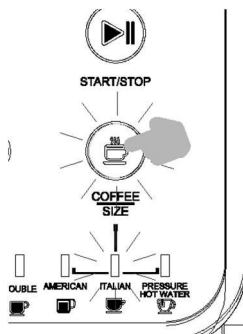

1. Press the coffee type selection button to select Italian coffee.

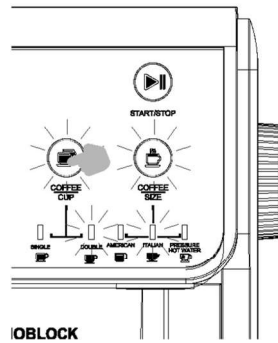

2. Press the coffee capacity selection button to select dual cups.

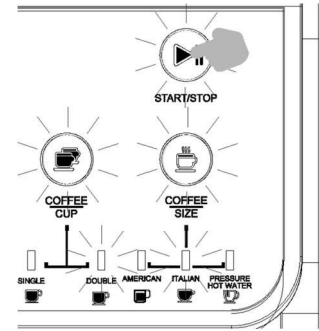

3. Press the start/stop button once, and the coffee machine will enter the double cup coffee brewing function.

At the same time, the start/stop button indicator light, coffee capacity selection button indicator light, Italian coffee indicator light, and double cup indicator light will flash. When the set flow rate is reached (about 60 ml), the coffee machine will automatically stop producing coffee, and the double cup coffee function will end. The entire machine will enter the preheating state.

## User Defined Espresso Cup Quantity

Users can adjust the specific flow rate of espresso according to their usage habits and needs, as follows:

### Customized Settings for Italian Single Cup Flow Rate

In the coffee system preheating state - install a single cup filter into a funnel and fill it with about 13 grams of coffee powder. Use a powder hammer to flatten the coffee powder and press it down tightly, then align the funnel assembly with the funnel bracket clamp and rotate it counterclockwise to lock it into the funnel bracket. Place the coffee cup on the cup cushion, as shown in the following operation:

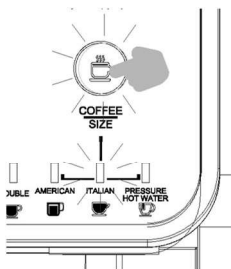

1. Press the coffee type selection button to select Italian coffee.

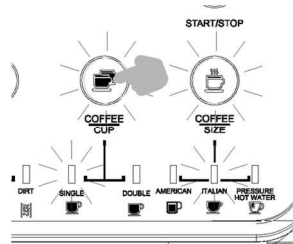

2. Press the coffee capacity selection button to select a single cup.

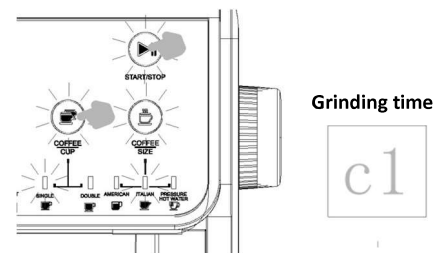

3. Press and hold the coffee capacity selection key and the start stop key simultaneously.

At this time, the start/stop key indicator, the coffee capacity selection key indicator, the single cup indicator, the coffee type selection key indicator, and the Italian coffee indicator flash, and the display play will show C1.

Start performing single cup Italian brewing. When the flow rate reaches the user's desired amount, press the start/stop button once, and the coffee machine will stop producing coffee. At this time, the coffee machine will record the user's set Italian single cup flow rate. When the user uses it again, the flow rate of the Italian single cup will be executed based on the user's last set flow rate.

**Note: Only flow rates between 22 – 46ml are considered valid records. When flow is lower than 22ml, the system records flow at 22ml. When flow is greater than 46 ml, the system records flow at 46ml.**

### Italian Double Cup Flow Customization Settings

In the preheating state, install the double cup filter into a funnel, fill about 19 grams of coffee powder, use a powder hammer to flatten the coffee powder and press down tightly. Then align the funnel assembly with the funnel bracket clamp, rotate it counterclockwise to lock it into the funnel bracket. Place the coffee cup on the cup cushion, as shown in the following operation:

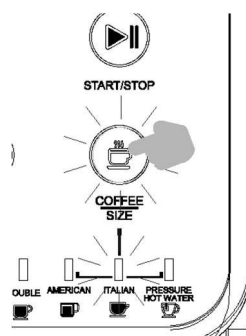

1. Press the coffee type selection button to select Italian coffee.

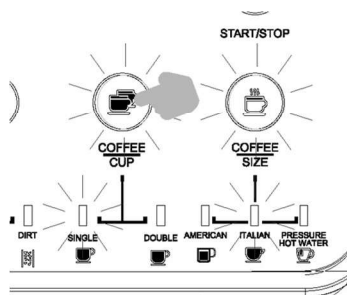

2. Press the coffee capacity selection button to select a double cup.

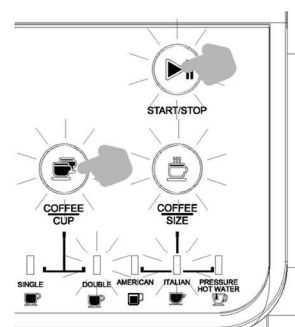

3. Press and hold the coffee capacity selection key and the start stop key simultaneously.

At this time, the start/stop key indicator, the coffee capacity selection key indicator, the double cup indicator, the coffee type selection key indicator, and the Italian coffee indicator will flash, and the display panel will show C1.

Start performing double cup Italian brewing. When the flow rate reaches the user's desired amount, press the start/stop button once, and the coffee machine will stop producing coffee. At this time, the coffee machine will record the user's set Italian double cup flow rate. When the user uses it again, the flow rate of the Italian double cup will be executed based on the user's last set flow rate.

#### Grinding time

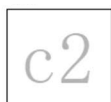

4. At the same time, the display panel will show C2.

**Note: Only flow rates between 45 – 90ml are considered valid records.**

**When flow is lower than 45ml, the system records 45ml.**

**When flow is greater than 90ml, the system records 90ml.**

## Restore Default Cup Size for Italian Single/Double Coffee Separately

Restore the default cup size of Italian single cup coffee separately under the preheating state of the coffee system, as shown below:

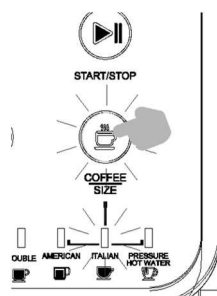

1. Press the coffee type selection button to select Italian coffee.

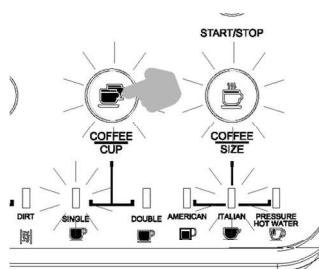

2. Press the coffee capacity selection button to select a single cup.

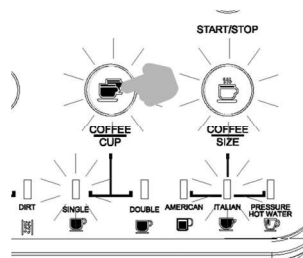

3. Press and hold the coffee capacity button.

At this time, the coffee capacity selection button indicator will light and the single cup indicator light will flash.

r1

4. The display panel will show r1, and then the coffee machine will return to the preheating state.

Restore the default cup size of Italian double cup coffee separately in the coffee system preheating state, as shown below:

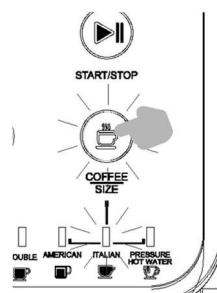

1. Press the coffee type selection button to select Italian coffee.

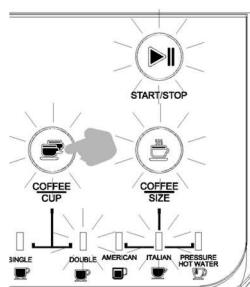

2. Press the coffee capacity selection button to select dual cups.

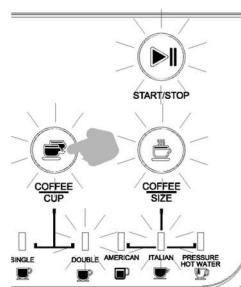

3. Long press and hold the coffee capacity button.

At this time, the coffee capacity selection button indicator light and the dual cup indicator light will flash.

r2

4. The display panel will show r2, and then the coffee machine will return to the insulation state.

**Note:** Steam function will produce high temperature steam, take care to avoid burns when using it. To ensure the foaming effect of milk, please wait for the steam function to run for 3-5 seconds, turn the

knob to the O position, then extend the steam pipe into the milk, then turn the knob to the steam position to foam the milk.

The maximum usage time of the steam function is 2 minutes. After using this function, please promptly turn the knob to the positive 0 position.



## Nozzle Function: Steaming

While the coffee machine is in the preheating state - press the nozzle function selection button to select the steam function. When the steam/hot water knob is turned to the steam/hot water position, the nozzle function selection button indicator light and the steam function indicator light will flash. The nozzle starts to produce steam, and when the steam/hot water knob is turned to the O position, the nozzle function selection button indicator light and the steam function indicator light remain on. The coffee machine stops producing steam.

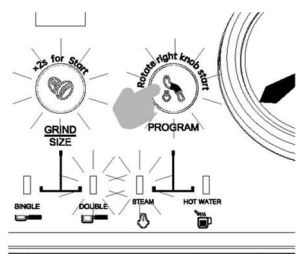

1. Press the nozzle function selection button once to select the steam function.

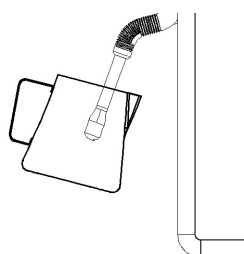

2. Place the latte art pot under the steam pipe.

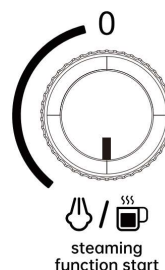

3. Turn the steam/hot water knob to the steam/hot water position, and the machine begins to produce steam.

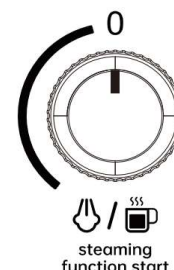

4. Return the steam/hot water knob to the O position to exit the steam function.

**Note: The entire working time for steam production is 2 minutes, and after 2 minutes, the machine will automatically exit the steam function. To return the steam/hot water knob to the O position.**

## Nozzle Function for Discharging Hot Water (Warm State)

To discharge hot water, press the nozzle function button to select the hot water function. When the steam/hot water knob is turned to the steam/hot water position, the nozzle function button indicator will light, the hot water function indicator light will flash, and the nozzle will begin to discharge hot water. To stop hot water discharge, turn the steam/hot water knob to the O position.

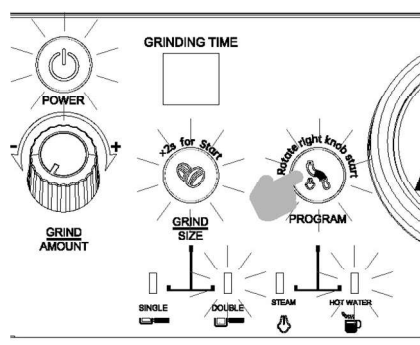

1. Press the nozzle function selection button to select the hot water function.

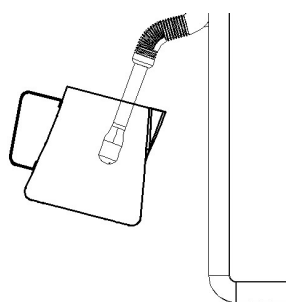

2. Place the water cup under the steam pipe.

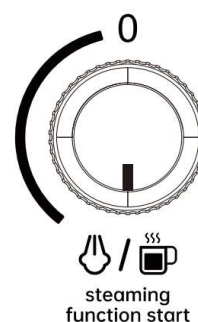

3. Turn the steam knob to the steam position, and the machine begins to produce hot water.

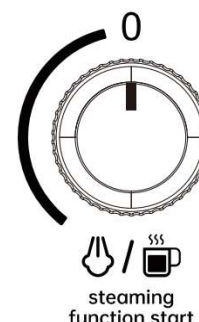

4. Turn the steam/hot water knob back to the O position to exit the hot water function.

**Note: The entire working time for hot water production is 2 minutes, and after 2 minutes, the machine will automatically exit the hot water function. To return the steam knob to the O position.**



# Operating Instructions



## Set Coffee Beans Extraction Temperature

The steam pipe has a set extraction temperature function. You can adjust the extraction temperature of the coffee beans within an adjustable range of 88 - 96°C. Each gear adjustment equates to 2°C, meaning the machine meets a different taste requirement per gear adjustment.

The higher the temperature the higher the coffee bitterness and the lower the acidity. When the set temperature is low, the bitterness will decrease and the acidity will increase.

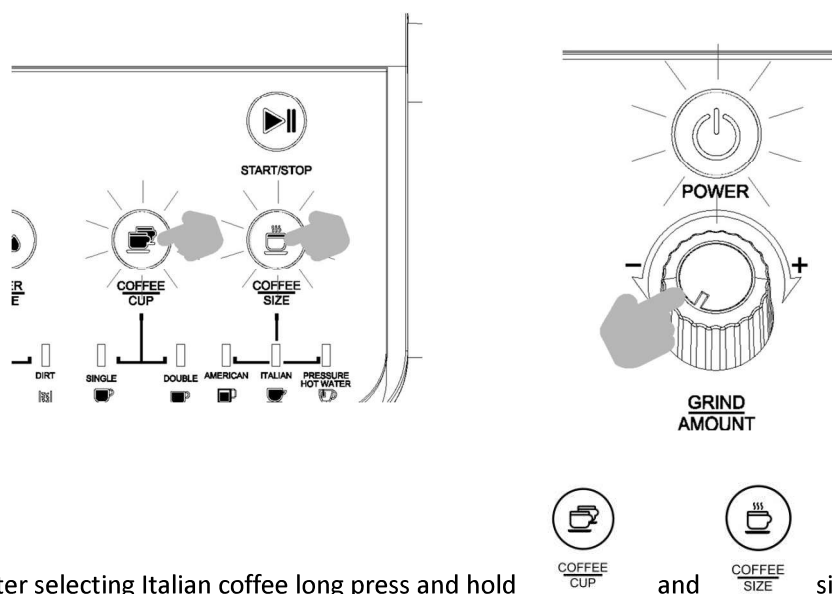
Enter extraction temperature setting mode:





In the preheating state, after selecting Italian coffee long press and hold  and  simultaneously. At the same time, the coffee capacity button indicator light, coffee type button indicator light, single cup coffee indicator light, the double cup coffee indicator light, the American coffee indicator light, the Italian coffee indicator light will flash to enter the temperature setting mode. Turn the left grinding time adjustment knob to select the temperature gear. The display panel will display the corresponding temperature range. At this time, the display panel will display any of t1, t2, t3, t4, t5. After determining the required temperature, press the start/stop button or the power key once, and the coffee maker will determine the current set temperature.

**Note: Coffee capacity button, coffee type button indicator light, single cup coffee indicator light, double cup coffee indicator light, American coffee indicator light, Italian coffee indicator light flashing indicates that the machine is in the temperature setting mode.**

## Temperature Set Mode

Important Reminder:

1. After entering the temperature setting state, if the grinding time knob is not turned within 10 seconds, the coffee machine will automatically exit this state and return to the preheating state, and confirm the final temperature setting.

2. During the setting process, press the  or  power on button once to exit the setting state and determine the current set temperature range.

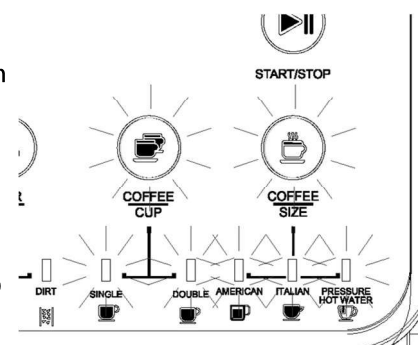

### Temperature Setting Display Code Definition

- E1** Italian or American coffee extraction temperature 88°C
- E2** Italian or American coffee extraction temperature 90°C
- E3** Italian or American coffee extraction temperature 92°C
- E4** Italian or American coffee extraction temperature 94°C
- E5** Italian or American coffee extraction temperature 96°C

### Water Tank Shortage Prompt

When the water tank is short of water, the machine will remind the user to pay attention.

The cleaning mode button indicator light, coffee capacity button indicator light, coffee type button indicator light will flash, and the upper left display screen will display the EP code.

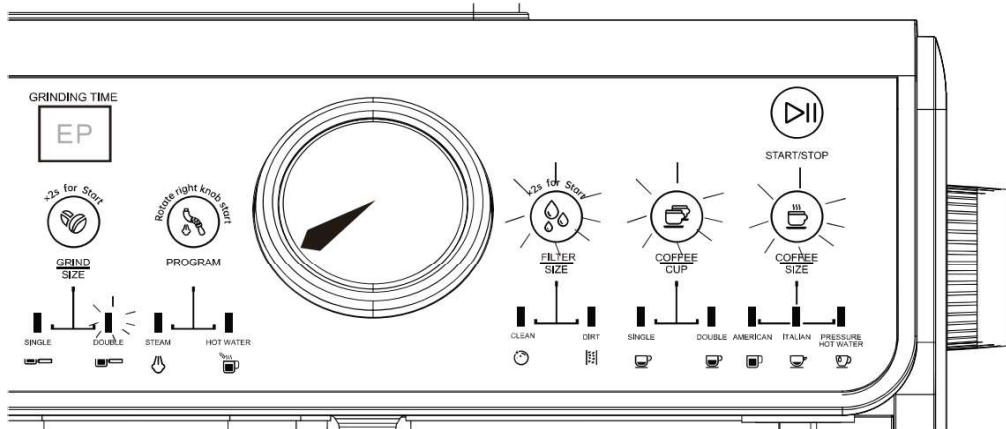

**Note: When using extremely fine coffee powder the machine may not be able to produce coffee. The above prompt will appear in this instance. A buzzer alarm sounds 5 times. If there is no action after one minute, the machine will enter standby mode.**

### Standby Mode

If there are no buttons or knobs operated for 30 minutes in the power-on state, the machine will automatically enter standby mode. Press the power button in standby mode to activate the coffee machine and enter preheating mode again.

#### Recommendation:

We suggest that you preheat the utensils, including the funnel, filter, and cup, before extracting coffee, so that the coffee will not be affected by cold utensils. The specific method can be to place the filter without powder into the funnel, screw the funnel into the funnel bracket, place the cup, select a single or double cup of coffee to execute. Allow hot water to flush down the high-pressure funnel for preheating, before stopping. Then you may launch a coffee extraction process.



## Grinding Coffee Beans

This machine has a coffee bean grinding function. Before using this function, please ensure that all components are installed in place as required. The details are as follows:

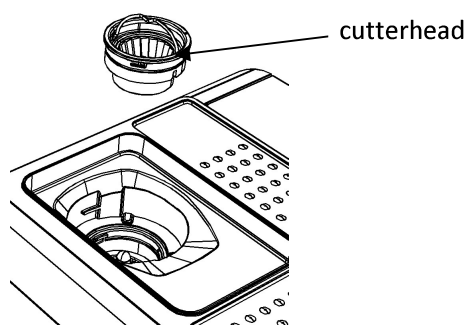

1: The cutterhead has been installed and tightened clockwise.

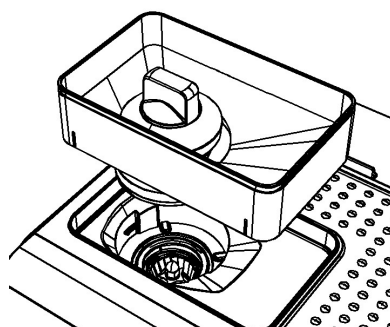

2: Put the bean box into the machine.

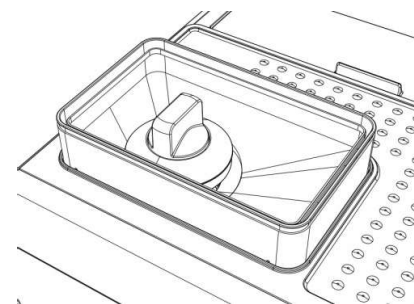

3: Turn the bean box knob to lock the bean box.

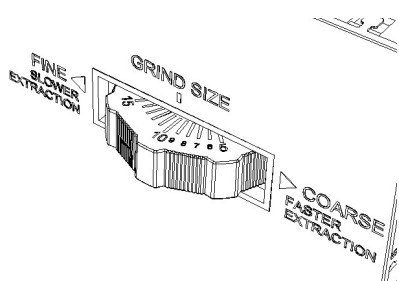

It is recommended to adjust to 10th gear for initial use.

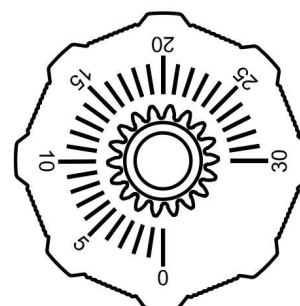

The larger the number, the larger the powder particles produced.

## Instructions for Grinding Coffee Beans Function

**Note:** Add an appropriate amount of coffee beans to the bean box. Do not put too many coffee beans in the bean box to avoid moisture affecting the grinding and final coffee taste.

### Double Cup Grinding

After ensuring that the coffee cup has been installed in place and filter screen rotated to lock, this coffee machine is plugged in and turned on. Steps as set out below:

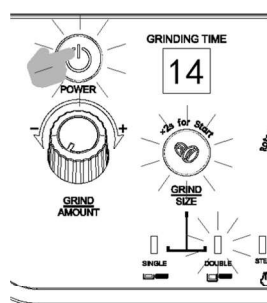

1. Press the power button to turn on the machine.

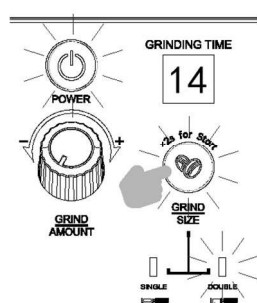

2. Press the grinding capacity selection button to select double cups.

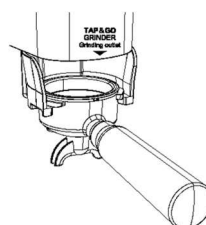

3. Place the double cup filter screen into the funnel before placing it in the left powder receiving bracket.

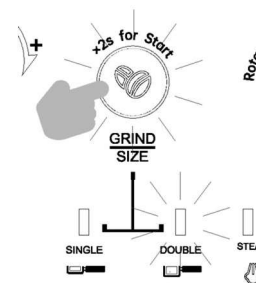

4. Press and hold the grinding capacity key, the grinder will start and automatically stop after reaching the set grinding time. During the process, you can also press the grinding capacity key to exit the grinding function in advance.

**Note: After powering off restart the coffee machine and set the grinding time for two cups. In the grinding gear range of 10-5, the grinding machine produces about 19g of powder. Depending on the roasting and freshness of coffee beans the grinding time and gear may need to be adjusted slightly.**

## Single Cup Grinding

After ensuring that the coffee cup has been installed in place and filter screen rotated to lock, this coffee machine is plugged in and turned on. Steps as set out below:

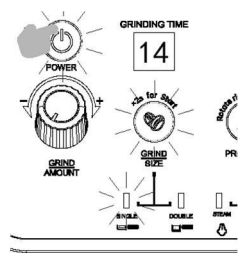

1. Press the power button to turn on the machine.

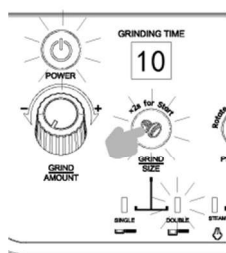

2. Press the grinding capacity selection button to select a single cup.

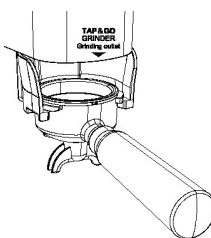

3. Place the single cup filter screen into the funnel before placing it in the left powder receiving bracket.

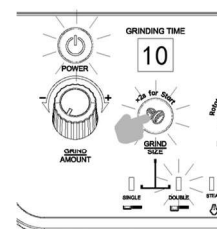

4. Long press and hold the grinding capacity key to start the bean grinder.

After reaching the set grinding time, it will automatically stop. During the process, you can also press the grinding capacity key to exit the bean grinder function in advance.

**Note: Single cup grinding time is about 10 seconds producing about 13g of powder. Dependent on the roasting and freshness of coffee beans the grinding time and gear may need to be adjusted slightly.**

5. Take out the funnel and tap it on the desktop to pre lay the coffee powder in the filter.

6. Use a powder hammer to flatten the coffee powder.

7. Rotate the funnel counterclockwise into the funnel bracket, and select the corresponding single or double cup coffee according to the cup size of the filter screen used using the coffee capacity selection button.

## Instructions for Grinding Beans Function

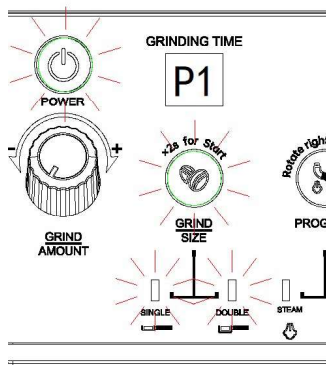

Figure 8

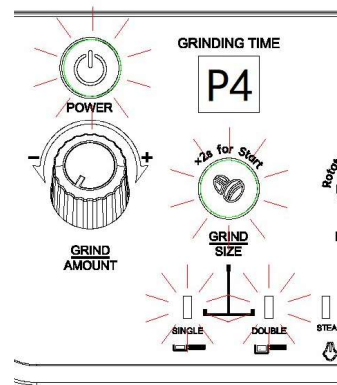

Figure 9

### Note:

1. When the bean box is not installed the grinding capacity button indicator light, single cup grinding indicator light, and double cup grinding indicator light will flash. The display panel will display P1 alarm code (Figure 8) accompanied by a buzzer alert sound.
2. To protect the bean grinding system, when the continuous use of the bean grinding function accumulatively exceeds 3 minutes, the system will limit the normal use of the bean grinding function for 6 minutes. At this time, the display panel will display the P4 alarm code (Figure 9). After the end of the 6 minutes of restricted use, the limit will be automatically lifted, and the bean grinding system will return to normal. At this time, the display panel will no longer display the P4 alarm code.
3. When the grinding system is restricted by the system, press the grinding capacity button and the machine will not respond.

## Instructions for Grinding Beans Function: A Customized Memory Function for Grinding Bean Time.

This product allows users to independently set and memorize the grinding time. The specific operation method is as follows:

### Customized Memory for Single Cup Grinding Time

When the display panel displays the grinding time, select a single cup for grinding, turn the grinding time adjustment knob to set your preferred grinding time, then press and hold the power button and grinding capacity button simultaneously. At this time, the power switch key indicator, grinding capacity key indicator, single cup grinding bean indicator and display panel will display GS - which will flash 3 times. The machine will confirm and remember this single cup grinding bean setting time. Next time using a single cup grinding bean, the same grinding setting will be used.

For example: if the single cup grinding time is adjusted from 10 seconds to 8 seconds, and the next time the machine is turned on, the single cup grinding time will be remembered as 8 seconds.

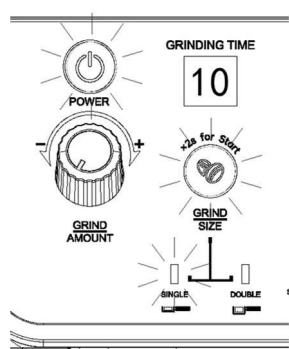

1. Rotate the left knob to adjust the grinding time of a single cup from e.g., 10 seconds to 8 seconds.

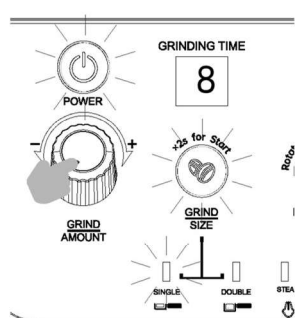

2. Adjust to 8 seconds.

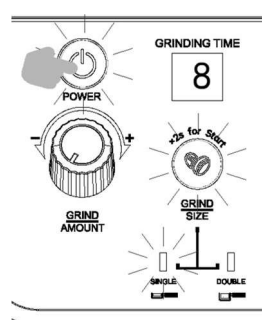

3. Simultaneously press and hold the power button and grinding capacity button to save time.



4. Display panel will display GS.

### Customized Memory for Double Cup Grinding Time

When the display panel displays the grinding time, select double cups of grinding, turn the grinding time adjustment knob to set your preferred grinding time, then press and hold the power button and grinding capacity button simultaneously. At this time, the power switch key indicator, the grinding capacity key indicator, the double cup grinding bean indicator and the display panel will display GS - which will flash for three times. The machine will confirm and remember this double cup grinding bean setting time. Next time using a double cup grinding bean, the same grinding setting will be used.

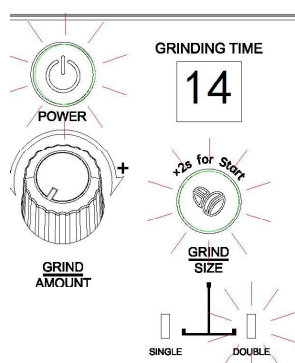

1. Rotate the left knob to adjust the double cup grinding time from e.g., 14 seconds to 13 seconds.

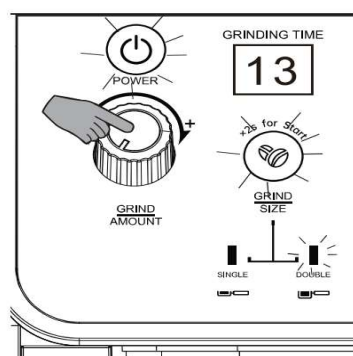

2. Double cup grinding time is 13 seconds.

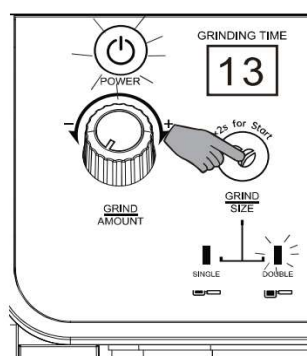

3. Simultaneously press and hold the power button and grinding capacity button to save time.



4. Display panel will display GS.

## The Default Time Setting for Restoring Single and Double Cup Grinding Beans

Press and hold the grinding capacity and start/stop buttons (Figure 10), the display panel will display rG (Figure 11), and the buzzer will sound. After that, the default time for grinding beans will be restored.

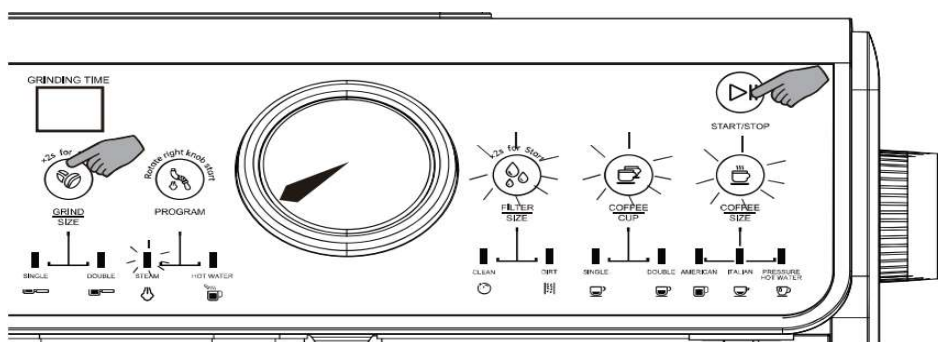

Figure 10

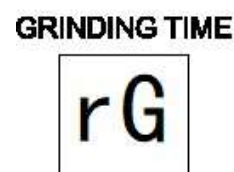

Figure 11

## Coffee Powder Grinding Recommendations

In order to obtain a uniform and consistent coffee powder it is necessary to adjust the powder thickness of the grinder according to the type and quality of the coffee beans being used – this will enable high-quality cup of coffee. The thickness of ground coffee powder is adjusted by changing the grinding powder thickness adjustment knob, as different types and qualities of coffee beans are used.

Fresh roasted coffee beans (within 1 month old) should be grounded between 10 and 5 gears.

## Restore Factory Settings

When the parameters of this coffee machine need to be restored to the factory settings, in the preheating state, users can simultaneously press and hold the nozzle function selection button, cleaning mode selection button, coffee capacity selection button, and coffee type selection button. At this time, the indicator light of the grinding capacity selection key, the indicator light of the nozzle function selection key, the indicator light of the coffee capacity selection key, and the indicator light of the coffee type selection key flash together, and the display panel displays rF. At this time, the system will return to the factory settings.

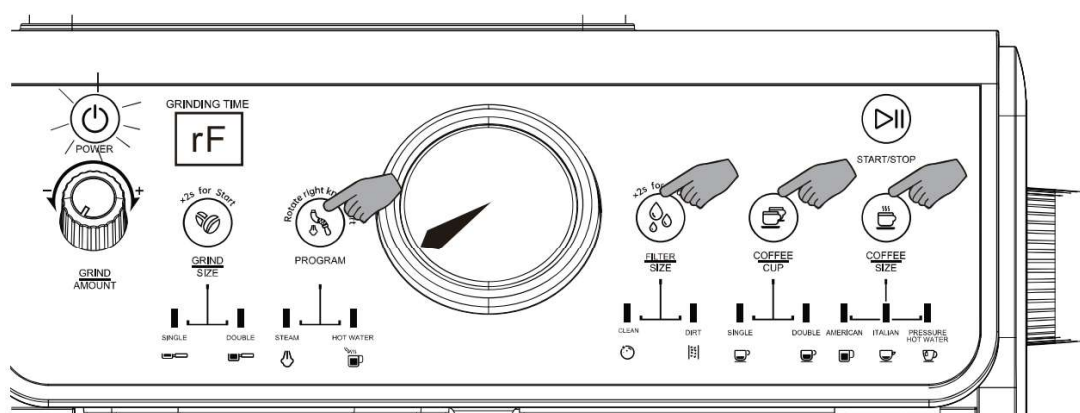

# Maintenance and cleaning

## Cleaning and Maintenance



**Warning: To avoid danger.**

Before maintenance, please unplug the plug and let the coffee machine cool sufficiently to prevent burns. Do not immerse the coffee machine or power cord plug in water or other liquids.

1. Clean all detachable components in water after each use. If necessary, add cleaning solution and rinse with clean water.
2. Usually, a moisture-proof sponge is used to scrub the outer surface of the coffee machine to remove dirt.
3. Rotate clockwise to remove the metal funnel and remove the coffee grounds inside, use a detergent to clean the funnel and metal filter accessories. Finally, you must rinse it thoroughly with clean water.
4. After cleaning all detachable components, wipe or air dry all components.

**Note: Do not immerse the machine in water for cleaning.**

**Detachable water tank, the water pan cannot be placed in the dishwasher for cleaning.**

## Cleaning Coffee Machine Outlets

Before cleaning, please let the coffee machine cool sufficiently. When the cleaning function is started, please ensure the following:

1. At least 1 liter of water in the water tank.
2. Empty the drain tray and install it in place.
3. Place the entire machine in a preheating state.
4. Place one cup under the coffee outlet and the other cup under the steam pipe.
5. When the cleaning program starts, the power button indicator light and the cleaning indicator light will flash throughout the entire operation process.
6. You can exit the cleaning process by pressing the power button.

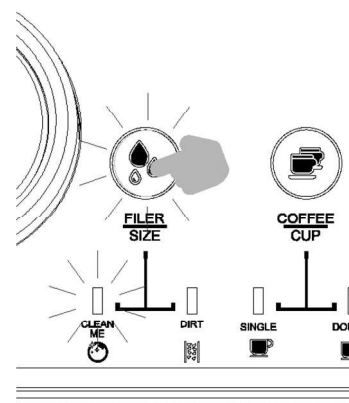

Press the cleaning function selection button once in the preheating state to select the cleaning function, and then long press the cleaning function selection button. This coffee machine will start cleaning the brewing head, hot water nozzle, and steam nozzle in sequence.



## Cleaning Function

Before performing the cleaning function, ensure that the water tank is filled with water and that the coffee system is in an preheating state.



1. Place a cup under the brewing head and hot water outlet.

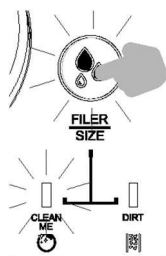

2. Press the cleaning mode selection key to select the cleaning function. Press and hold the cleaning mode selection button again to enter the descaling

GRINDING TIME



3. Display panel display C2.

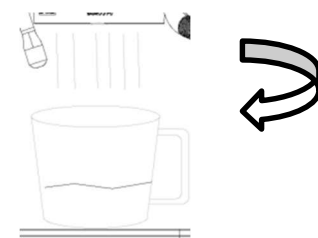

4. The coffee machine's brewing head starts to water out for 1 minute, at which point the user can use a brush to clean the brewing head.

GRINDING TIME



5. When the water from the brewing head is finished, the display panel will display C3 and turn to the waiting state. At this time, the user can prepare tools for scrubbing the hot water pipe.

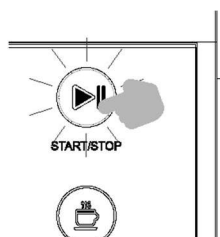

6. Press the start button once.

GRINDING TIME



7. Display panel will display C4.



8. The hot water pipe of the coffee machine starts to discharge for 1 minute, at which point the user can use a brush to clean the hot water pipe.

GRINDING TIME



9. When the hot water pipe is out of water, the display panel displays C5 and turns to the waiting state. At this time, the user can prepare tools to scrub the steam pipe.



10. Turn the steam/hot water knob to the steam/hot water position.

GRINDING TIME



11. Display panel displays C6.



12. The steam pipe of the coffee machine starts to water out for 1 minute, at which point the user can use a brush to clean the steam pipe.

13. Turn off steam/hot water to 0 position.

14. After the steam pipe is drained and cleaned, return to the preheating state.

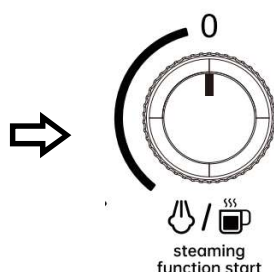

**Note:** During the cleaning function, you can press the power button to exit the cleaning function.

## Scale Removal Function

This coffee machine has a descaling reminder function and a descaling program which requires users' cooperation during the descaling process.

**Descaling instructions:** It is recommended that a descaling operation takes place every 2-3 months, or upon brewing 300 coffee cups or upon using 15L of water through the system. This coffee machine will prompt for descaling. It is recommended that users perform a complete descaling process on this coffee machine. Before the descaling prompt appears users can also perform descaling in advance to prevent limescale build up.

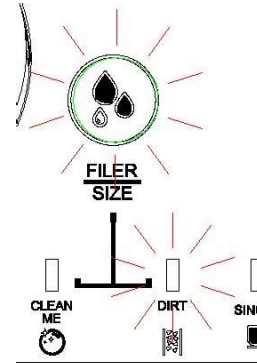

A prompt for descaling will appear once the descaling indicator light flashes.

**Note:** After completing a complete descaling operation, a record of the number of coffee cups brewed and record the amount of water used will reset to zero at the same time.

Potential descaling fluids:

- a) Coffee machine scale remover / table
- b) White vinegar and warm water

**Note:** After the descaling reminder is started or before the user starts the descaling program independently, please complete the following descaling preparation work before running the descaling program.

## Preparation for Descaling

Add solution to the water tank (choose one of the two methods a/b)

- Fill water to the recommended water level for descaling agent of the water tank. Add descaling tablets and wait for them to dissolve, or
- Add 1.5 spoons of white vinegar to the water tank, then fill water into the recommended water level of the descaling agent in the water tank to thoroughly mix the solution.

Insert the water tank in place

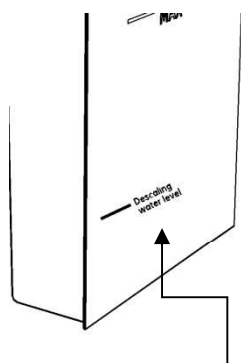

Recommended water level  
for descaling agents

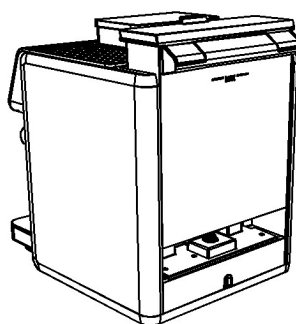

Insert the water tank  
in place

## Descaling Mode

Place a 1-liter container under the brewing head and another 1-liter container under the steam duct.

After completing the above steps, the descaling program can be started as follows:

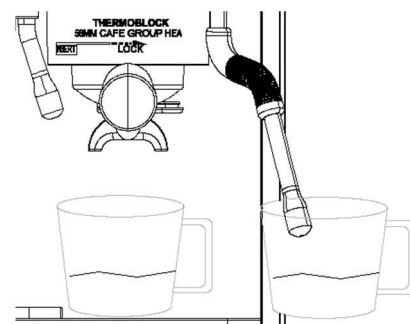

Step 1: Start descaling execution

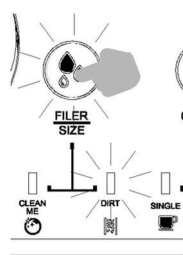
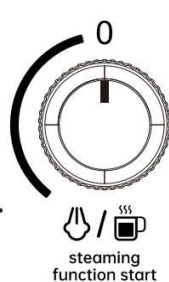

GRINDING TIME



1. Confirm if the steam/hot water knob is turned to the 0 position.

2. After selecting descaling through the cleaning mode selection button, long press the cleaning mode selection button to enter step d2.

3. Display panel displays d1.

4. Turn the steam/hot water knob to the steam/hot water position.

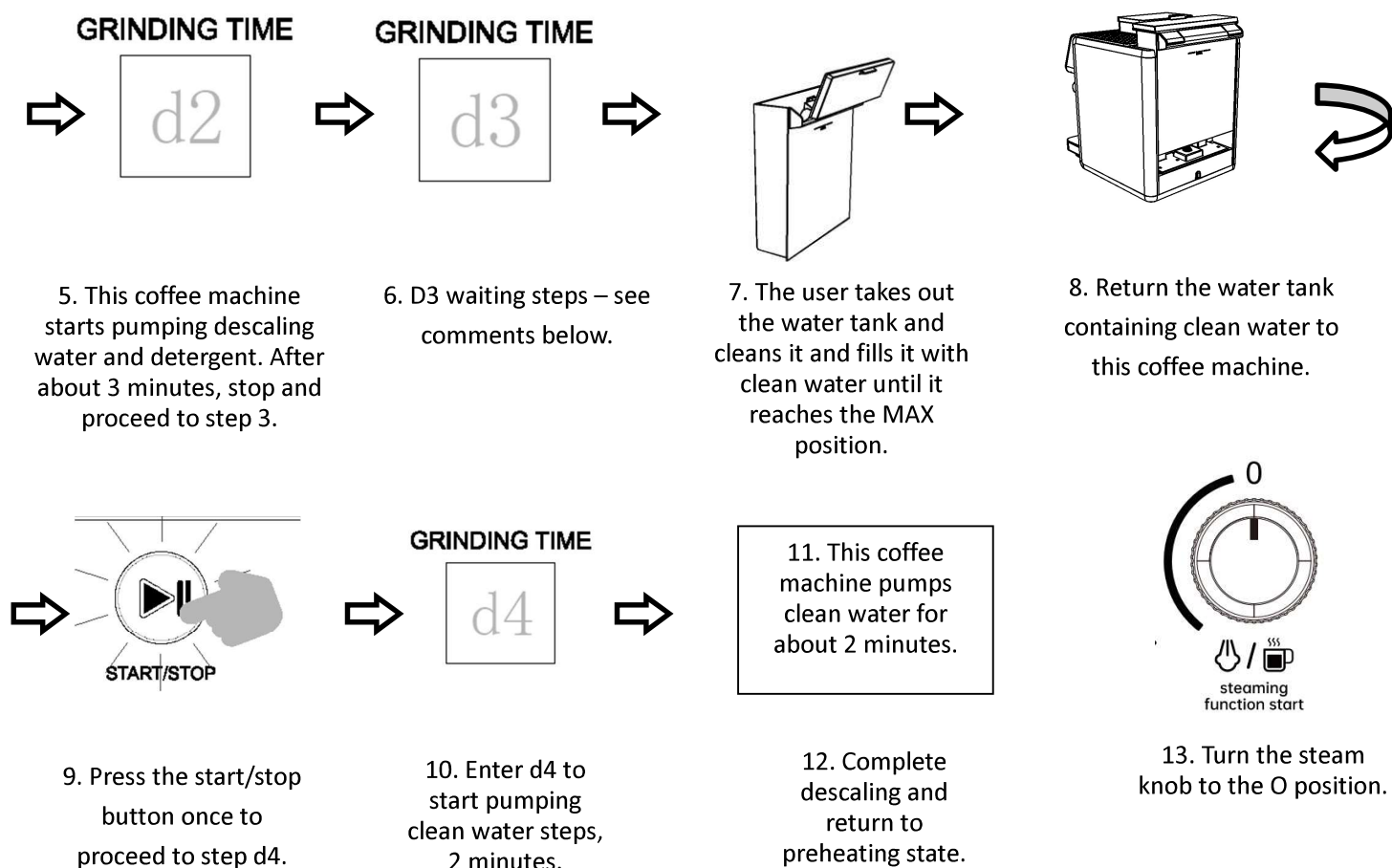

The d3 waiting step (30 minutes) facilitates users to clean the water tank and replace it with clean water. In d3, you can press the start stop button to advance to the next step d4. Steps d2 and d4 must be completed to prevent residual descaling agent remaining in the system water pipeline. At any step from d2 to d4, the descaling mode can be interrupted in advance by pressing the power button. If d2 has been executed but d4 steps have not been completed a prompt of nF (Descal Not Finish-incomplete descaling). Under the prompt of nF it is necessary to force another complete descaling process to be completed before releasing nF.

**Note:**

For step d3 allow a maximum of 30 minutes to complete the following tasks:

- It is necessary to use clean water to clean the steam conduit and brewing head, and empty the residual descaling agent solution in the water tank.
- Flushing water tank.
- Fill the water tank with clean water to the maximum (MAX) water level line of the water tank.
- Empty the container, use a clean cloth, brush, and other tools, and wipe the brewing head, hot water nozzle, and steam nozzle head with clean water.

## Daily Maintenance of Bean Grinder

During the use of the bean grinder and grinding process it is not uncommon for the powder outlet channels to hold ground powder which eventually can lead to blockages. Please be sure to clean the powder outlet channel periodically to avoid blockages. It is recommended to clean the powder outlet and grinding wheel at least once every two weeks. The following process may be used to:

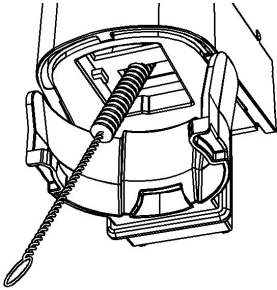

1. Clear channel location.

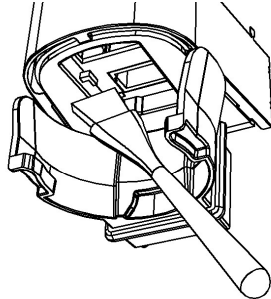

2. Clean plasma position.

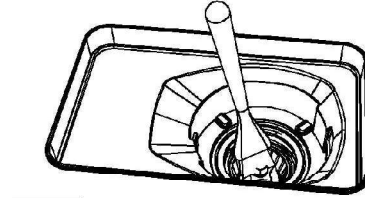

3. Clean the grinding chamber of the cutter head.

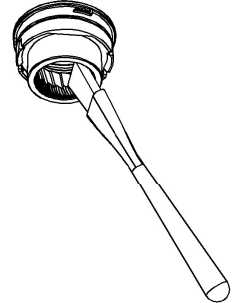

4. Clean the cutter head.

### Recommendations:

1. Once you have powered off the machine, clean the powder outlet and grinding wheel at least once every two weeks.
2. When there is a decrease in powder output, clean the powder output channel and grinding wheel.
3. When using a bean grinder to grind fine coffee powder clean the powder channel regularly.
4. This machine is equipped with a static electricity removal and anti-fly powder system. When the coffee powder floats out of the funnel range use a brush to clean the position of the powder crossing in a timely manner.

### Cleaning Method for Bean Grinder

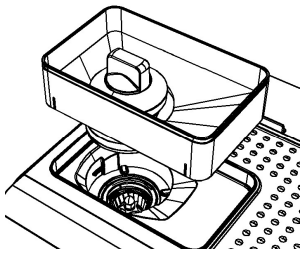

1. Rotate the bean box knob to remove the bean box and empty any excess coffee beans and powder from the box.



2. Rotate the internal grinding wheel counterclockwise out.

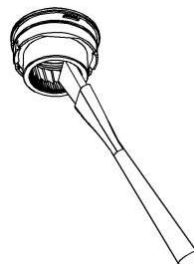

3. After removal, use a cleaning brush to clean the grinding wheel and remove any coffee powder from the gaps.

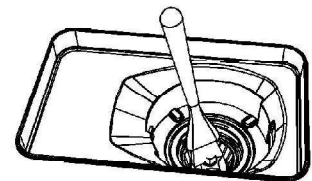

4. Do not install the grinding wheel at this time and reinstall the empty bean box.

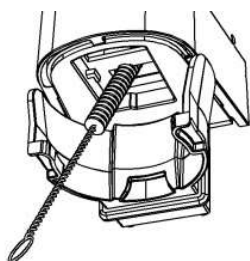

5. Clean the grinding chamber with a cleaning brush.

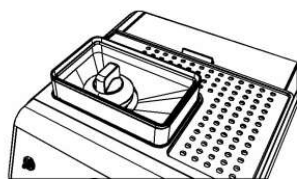

6. Do not install the grinding wheel at this time but reinstall the empty bean box and power on the machine.

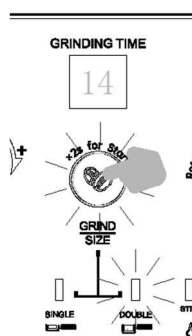

7. Long press the grinding capacity selection button to activate the grinding function. empty bean box.

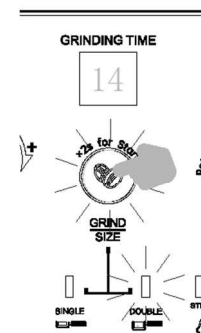

8. Run the grinder to sweep out the remaining powder from the grinding chamber. (If not cleaned, please repeat steps 3, 4, and 5). grinding function. empty bean box.

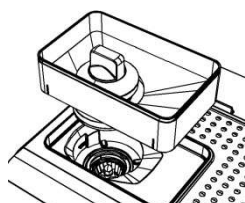

9. Power off the machine and remove the bean box counterclockwise.

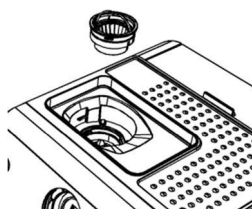

10. Install the grinding wheel clockwise.

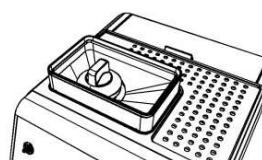

11. Rotate the bean box knob to install the box.

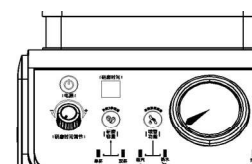

12. Close the bean box lid and complete the cleaning.

#### Note:

**When cleaning the bean grinder ensure that there are no beans in the bean box. When the bean grinder button is pressed the bean grinder can operate normally until there is no coffee powder flowing out of the powder outlet, and then stop grinding immediately.**

**The grinding wheel must not be directly cleaned or rinsed with water.**

#### Grinding Anomaly Resolution

When grinding coffee, the display panel may display P2 because the ground coffee powder is too fine. In this instance power off the machine and repeat steps 1-5 (of **Cleaning method for bean grinder**) taking out the bean box and cutterhead, and cleaning the grinder and powder outlet channel again.



## Other Maintenance:

### Clean the Drain Tray

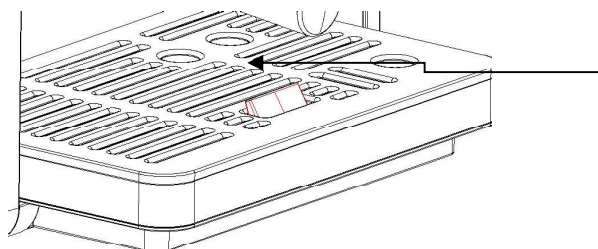

During the working process, the buoy floats, and it is necessary to remove the drain pan and pour out the water inside to avoid leakage outside the machine.

### Environmental protection treatment



#### Correct Disposal of this product

This marking indicates that this product should not be disposed with other household wastes throughout the UK. To prevent possible harm to the environment or human health from uncontrolled waste disposal, recycle it responsibly to promote the sustainable reuse of material resources. To dispose your used device take this product for environmental safe recycling at your local waste disposal site.

### Food Hygiene Labeling

Product Name: BridgePro Semi-Professional Espresso Coffee Machine

## Troubleshooting

Fault	Reason	Solution
No display	Check if the plug is properly inserted and if the power switch is pressed.	Insert the power plug and ensure that the power button is turned on.
The front panel display screen of the machine shows P1	No bean box installed	Install the bean box
There are water stains on the bottom of the machine	The water tank or drain pan is not installed in place. The drain pan is full.	Ensure that the water tank and drain box are installed in place. and the drain tray has been emptied.
After turning on the machine, you will hear a "Dida" sound and a hissing sound after coffee is produced.	This is a normal phenomenon and the sound is generated by the normal operation of the pressure control valve.	
The funnel does not produce coffee or flows drop by drop, or the funnel cannot rotate properly.	Excessive amount of coffee powder being used or the coffee powder is too fine or the pressure on the powder is too high.	The amount of powder should not exceed the standard, adjust the grinding gear of the bean grinder appropriately until it is suitable. When pressing powder it is not advisable to use excessive force to press.
Coffee is fat free.	The coffee beans are damp or the coffee powder is too thick.	Choose fresh coffee beans and ground powder with moderate fineness for brewing coffee.
No steam output.	The steam function is not fully preheated, and the steam nozzle is blocked.	The machine can only generate steam after steam preheating is completed. Or the machine needs to be descaled.



## Fault Codes

Code display	Reason	Solution
Panel display P1	The bean box is not loaded.	Install the bean box and lock the knob clockwise.
Panel display P2	Motor stalling.	Power off the machine, clean the powder discharge channel, cutter head, and the grinding chamber. Remove blockages or hard foreign objects. Power on the machine.
Panel display P3	Grinding bean motor open circuit.	Power off, rest for 2 minutes, and then power on the machine. Should the fault code reappear contact us at <a href="mailto:info@bgepro.com">info@bgepro.com</a> with your name, copy of your purchase receipt, and the serial number at the back of your machine.  Please do not disassemble the machine without permission.
Panel display P4	Bean grinding motor timeout protection.	Allow the machine to rest for 6 minutes, the machine will automatically release P4.
Panel display E0	Abnormal communication between power board and display control board.	Power off, rest for 2 minutes, and then power on the machine.  Should the fault code reappear contact us at <a href="mailto:info@bgepro.com">info@bgepro.com</a> with your name, copy of your purchase receipt, and the serial number at the back of your machine.  Please do not disassemble the machine without permission.
Panel display E1	The coffee boiler temperature detection unit is abnormal.	
Panel display E2	The steam boiler temperature detection unit is abnormal.	
Panel display E4	Water flow meter detection unit is abnormal.	
Panel display E5	Stuck-open fault for brewing coffee boiler circuit (excludes any action of thermostat).	
Panel display E6	Stuck-open fault for steaming boiler circuit (excludes any action of thermostat).	
Panel display E7	Stuck-open and short-circuit fault for voltage detecting circuit (ADC<50, ADC>).	
Panel display E8	Exceeding of power voltage (<186V of >266V).	
Panel display E9	Over zero circuit is abnormal or power supply frequency mismatching.	

If the cause of the problem is not found, please do not disassemble the machine.

Contact us at [info@bgepro.com](mailto:info@bgepro.com) with your name, copy of your purchase receipt, the serial number at the back of your machine, and the fault description.

# Terms & Condition of Purchase

BridgePro Management Ltd ("BPM").

**Limited Warranty:** This product is guaranteed for 12 months from the date of original purchase. This guarantee is valid in the UK only. If any defect arises due to faulty materials or workmanship, the faulty products must be returned to the place of purchase. Refund or replacement is at the discretion of the retailer.

The following conditions apply:

- The product must be returned to the retailer with proof of purchase or a receipt.
- The product must be installed and used in accordance with the instructions contained in this instruction guide.
- It must be used only for domestic purposes.
- It does not cover wear and tear, damage, misuse or consumable parts.
- The product has limited liability for incidental or consequential loss or damage.

To validate your warranty, please visit [www.bgepro.com/support/warranty/](http://www.bgepro.com/support/warranty/) and register with us online. Warranty is only valid with proof of purchase or receipt.

This product warranty is available to consumers only.

You are a consumer if you purchased the product at retail for personal, family, or household use. Except as otherwise stated under applicable law, this warranty is not available to retailers or other commercial purchasers and owners.

This product warranty is void if the product is used for situations other than a single-family household use or subjected to any voltage and wave forms other than as specified in this instruction manual (e.g., 220V-50Hz).

**Transportation charges:** Transportation charges for products under this warranty, subject to repair or replacement, shall be borne by the purchaser.

**Conditions:** Service centers or retail stores do not have the right to alter, modify, or in any way change the terms and conditions of this warranty.

Warranty registration is not necessary but is encouraged to validate product warranty.

**About your warranty:** Most warranty repairs or replacements are handled routinely but sometimes requests for warranty services may not be appropriate, e.g., warranty services would NOT apply if the product damage occurred because of misuse, lack of routine maintenance, shipping, handling, 3rd party warehousing, or improper installation. Similarly, warranty is void if the serial number on the product has been removed or the product has been altered or modified.

**Normal wear:** This warranty does not cover normal wear of any parts or damage resulting from any of the following negligent use or misuse of the product:

- Improper voltage or current,
- Use contrary to the operation instructions,
- Deviation from the instructions regarding storage and transportation, or
- Repair or alteration by any 3<sup>rd</sup> party.

This warranty does not cover Acts of God such as fire, flood, hurricanes, and tornados.

BPM shall not be liable for any incidental or consequential damages by the breach of any express or implied warranty.

Except to the extent prohibited by applicable law any implied warranty of merchantability or fitness for the particular purpose is limited in duration of this warranty.

## Notes